

# Standard Products

## Power Distribution Units

## Remote EPO Panels



April 2025

Standard Product Summary .....	SC-2
<b>Networked PDUs</b>	
Optima RCM 820 Series 1U Single-Phase PDUs .....	SC-9
Optima RCM 833 Series 3U Three-Phase PDUs .....	SC-15
Optima RCM 829 Series 0U Single-Phase PDUs .....	SC-20
Optima RCM MES 802 Simulator .....	SC-24
<b>Basic PDUs</b>	
Optima 520 Series 1U Single-Phase PDUs .....	SC-25
Optima 532 Series 2U Three-Phase PDUs .....	SC-30
Optima 533 Series 3U Three-Phase PDUs .....	SC-36
Optima 529 Series 0U Single-Phase PDUs .....	SC-41
Optima 539 Series 0U Three-Phase PDUs .....	SC-41
Optima 320 Series 1U Single-Phase PDUs .....	SC-46
Optima 329 Series 0U Single-Phase PDUs .....	SC-51
<b>EPO Control Panels</b>	
Commander UCP 5000 / 5100 Remote EPO Panel .....	SC-54
Commander UCP 4900 Remote EPO Panel .....	SC-59

Contact our power specialists: [info@marway.com](mailto:info@marway.com) • 800-462-7929

Innovating solutions for multiple industries and applications.



# Standard Product Summary



## Optima™ 8 RCM

### Networked Power Distribution Units

Industrial PDUs with Ethernet networking for inlet power monitoring and outlet switching over HTTP/S, Telnet, SSH, and SNMP. Features power setpoints, and user alerts over email, SMS, and SNMP. Integral surge suppressor, EMI filter, remote EPO, and more. Available in a variety of power forms in 15 A, 20 A, and 30 A maximum ratings.

#### Model Series

- Single Phase (1U) — 820 Series
- Three Phase (3U) — 833 Series
- Single Phase (0U) — 829 Series



## Optima™ 5 and 3 Series

### Basic Power Distribution Units

Industrial PDUs in a variety of power forms in 15 A, 20 A, and 30 A maximum ratings. Integral surge suppressor, EMI filter, remote EPO, and more.

#### Model Series

- Single Phase (1U) — 520 Series, 320 Series
- Three Phase (2U/3U) — 532/533 Series
- Single or Three Phase (0U) — 529/539 Series, 329 Series



## Commander™

### Remote Control and EPO Panels

- Connects to one or multiple PDUs.
- On/Off power control to connected PDUs.
- EPO for all connected PDUs.
- UCP 5000/5100 includes time meter, audible alarm, and convenience outlets on front and back.



## Other Products (visit our web site at [www.marway.com](http://www.marway.com))

Optima Custom Power Distribution Units

TwinPower Auto-transfer Switches

PowerPlus Intergrated Rack Services

# Standard Product Comparison

## Optima™ 820 Series • 1U



Model Number	Current	Voltage	Inlet	5-15 Outlets	5-20 Outlets	C13 Outlets
MPD 82101-PSW-000	12/15 A	120 Vac single phase	5-15P 9 ft Cable, Rear	5-15 (9)		
MPD 82102-PSW-000	16/20 A	120 Vac single phase	5-20P 9 ft Cable, Rear		5-20 (9)	
MPD 82103-PSW-000	16/20 A	120 Vac single phase	L5-20P 9 ft Cable, Rear		5-20 (9)	
MPD 82104-PSW-000	16/20 A	200-240 Vac single phase	L6-20P 9 ft Cable, Rear			C13 (9)
MPD 82105-PSW-000	16/20 A	100-240 Vac single phase	C20 Recessed, Rear			C13 (9)
MPD 82107-PSW-000	24/30 A	120 Vac single phase	L5-30P 9 ft Cable, Rear		5-20 (9)	
MPD 82108-PSW-000	24/30 A	200-240 Vac single phase	L6-30P 9 ft Cable, Rear			C13 (9)

## Optima™ 833 Series • 3U



Model Number	Current	Voltage	Inlet	5-20 Outlets	L5-20 Outlets	L5-30 Outlets	L6-20 Outlets	L6-30 Outlets	L21-30 Outlets
MPD 833005-PSW-000	24/30 A	120/208 Vac 3ph Wye	Recessed L21-30P Front Panel	5-20 (16)					
MPD 833006-PSW-000	24/30 A	120/208 Vac 3ph Wye	Recessed L21-30P Front Panel	5-20 (12)	L5-20 (2)				L21-30 (1)
MPD 833007-PSW-000	24/30 A	120/208 Vac 3ph Wye	Recessed L21-30P Front Panel	5-20 (12)		L5-30 (2)			L21-30 (1)
MPD 833008-PSW-000	24/30 A	120/208 Vac 3ph Wye	Recessed L21-30P Front Panel	5-20 (12)			L6-20 (2)		L21-30 (1)
MPD 833009-PSW-000	24/30 A	120/208 Vac 3ph Wye	Recessed L21-30P Front Panel	5-20 (12)				L6-30 (2)	L21-30 (1)
MPD 833010-PSW-000	24/30 A	120/208 Vac 3ph Wye	Straight L21-30P 9 ft Cable, Rear	5-20 (16)					
MPD 833011-PSW-000	24/30 A	120/208 Vac 3ph Wye	Straight L21-30P 9 ft Cable, Rear	5-20 (12)	L5-20 (2)				L21-30 (1)
MPD 833012-PSW-000	24/30 A	120/208 Vac 3ph Wye	Straight L21-30P 9 ft Cable, Rear	5-20 (12)		L5-30 (2)			L21-30 (1)
MPD 833013-PSW-000	24/30 A	120/208 Vac 3ph Wye	Straight L21-30P 9 ft Cable, Rear	5-20 (12)			L6-20 (2)		L21-30 (1)
MPD 833014-PSW-000	24/30 A	120/208 Vac 3ph Wye	Straight L21-30P 9 ft Cable, Rear	5-20 (12)				L6-30 (2)	L21-30 (1)

# Standard Product Comparison

## Optima™ 829 Series • 0U



Model Number	Current	Voltage	Inlet	Height	5-20 Outlets	C13 Outlets	C19 Outlets
MPD 829001-PSW-000	16/20 A	100-240 Vac 1ph	C20 Recessed Male	Full Rack		C13 (18)	C19 (6)
MPD 829003-PSW-000	16/20 A	200-240 Vac 1ph	L6-20P 15 ft Cable	Full Rack		C13 (18)	C19 (6)
MPD 829004-PSW-000	24/30 A	200-240 Vac 1ph	L6-30P 15 ft Cable	Full Rack		C13 (18)	C19 (6)
MPD 829006-PSW-000	16/20 A	100-120 Vac 1ph	5-20P 15 ft Cable	Full Rack	5-20 (24)		
MPD 829007-PSW-000	16/20 A	100-120 Vac 1ph	L5-20P 15 ft Cable	Full Rack	5-20 (24)		

# Standard Product Comparison

## Optima™ 520 Series • 1U



Model Number	Current	Voltage	Inlet	5-15 Outlets	5-20 Outlets	C13 Outlets
MPD 520012-000	12/15 A	120 Vac single phase	5-15P 9 ft Cable, Rear	5-15 (12)		
MPD 520024-000	16/20 A	120 Vac single phase	5-20P 9 ft Cable, Rear		5-20 (12)	
MPD 520036-000	16/20 A	120 Vac single phase	L5-20P 9 ft Cable, Rear		5-20 (12)	
MPD 520060-000	16/20 A	110–240 Vac single phase	C20 Recessed, Rear			C13 (12)
MPD 520084-000	24/30 A	120 Vac single phase	L5-30P 9 ft Cable, Rear		5-20 (12)	
MPD 520096-000	24/30 A	200–240 Vac single phase	L6-30P 9 ft Cable, Rear			C13 (12)

## Optima™ 532 Series • 2U



Model Number	Current	Voltage	Inlet	5-20 Outlets	L5-20 Outlets	L5-30 Outlets	6-20 Outlets	L6-20 Outlets	L6-30 Outlets	L21-30 Outlets
MPD 532004-000	24/30 A	120/208 Vac 3ph Wye	Straight L21-30P 9 ft Cable, Front	5-20 (8)						L21-30 (3)
MPD 532009-000	24/30 A	120/208 Vac 3ph Wye	Straight L21-30P 9 ft Cable, Front	5-20 (2)			6-20 (6)			L21-30 (3)
MPD 532014-000	24/30 A	120/208 Vac 3ph Wye	Angled L21-30P 9 ft Cable, Front	5-20 (8)						L21-30 (3)
MPD 532020-000	24/30 A	120/208 Vac 3ph Wye	Straight L21-30P 9 ft Cable, Rear	5-20 (8)	L5-20 (3)					
MPD 532021-000	24/30 A	120/208 Vac 3ph Wye	Straight L21-30P 9 ft Cable, Rear	5-20 (8)		L5-30 (3)				
MPD 532022-000	24/30 A	120/208 Vac 3ph Wye	Straight L21-30P 9 ft Cable, Rear	5-20 (8)				L6-20 (3)		
MPD 532024-000	24/30 A	120/208 Vac 3ph Wye	Straight L21-30P 9 ft Cable, Rear	5-20 (8)						L21-30 (3)
MPD 532025-000	24/30 A	120/208 Vac 3ph Wye	Straight L21-30P 9 ft Cable, Rear	5-20 (2)	L5-20 (3)		6-20 (6)			
MPD 532028-000	24/30 A	120/208 Vac 3ph Wye	Straight L21-30P 9 ft Cable, Rear	5-20 (2)			6-20 (6)		L6-30 (3)	
MPD 532029-000	24/30 A	120/208 Vac 3ph Wye	Straight L21-30P 9 ft Cable, Rear	5-20 (2)			6-20 (6)			L21-30 (3)

# Standard Product Comparison

## Optima™ 533 Series • 3U



Model Number	Current	Voltage	Inlet	5-20 Outlets	L5-20 Outlets	L5-30 Outlets	6-20 Outlets	L6-20 Outlets	L6-30 Outlets	L21-30 Outlets
MPD 533005-000	24/30 A	120/208 Vac 3ph Wye	L21-30P Recessed, Front	5-20 (16)						
MPD 533006-000	24/30 A	120/208 Vac 3ph Wye	L21-30P Recessed, Front	5-20 (12)	L5-20 (2)					L21-30 (1)
MPD 533007-000	24/30 A	120/208 Vac 3ph Wye	L21-30P Recessed, Front	5-20 (12)		L5-30 (2)				L21-30 (1)
MPD 533008-000	24/30 A	120/208 Vac 3ph Wye	L21-30P Recessed, Front	5-20 (12)				L6-20 (2)		L21-30 (1)
MPD 533009-000	24/30 A	120/208 Vac 3ph Wye	L21-30P Recessed, Front	5-20 (12)					L6-30 (2)	L21-30 (1)
MPD 533010-000	24/30 A	120/208 Vac 3ph Wye	L21-30P 9 ft Cable, Rear	5-20 (16)						
MPD 533013-000	24/30 A	120/208 Vac 3ph Wye	L21-30P 9 ft Cable, Rear	5-20 (12)				L6-20 (2)		L21-30 (1)

# Standard Product Comparison

## Optima™ 529 Series • 0U



Model Number	Current	Voltage	Inlet	Height	5-15 Outlets	5-20 Outlets	C13 Outlets	C19 Outlets
MPD 529001-000	16/20 A	110-240 Vac 1ph	C20 Recessed Male	Full Rack			C13 (36)	C19 (6)
MPD 529004-000	24/30 A	200-240 Vac 1ph	L6-30P 15 ft Cable	Full Rack			C13 (36)	C19 (6)
MPD 529005-000	12/15 A	100-120 Vac 1ph	5-15P 15 ft Cable	Full Rack	5-15 (36)			
MPD 529006-000	16/20 A	100-120 Vac 1ph	5-20P 15 ft Cable	Full Rack		5-20 (36)		
MPD 529008-000	24/30 A	100-120 Vac 1ph	L5-30P 15 ft Cable	Full Rack		5-20 (36)		
MPD 529009-000	16/20 A	110-240 Vac 1ph	C20 Recessed Male	Half Rack			C13 (18)	C19 (3)
MPD 529012-000	24/30 A	200-240 Vac 1ph	L6-30P 15 ft Cable	Half Rack			C13 (18)	C19 (3)
MPD 529014-000	16/20 A	100-120 Vac 1ph	5-20P 15 ft Cable	Half Rack		5-20 (18)		
MPD 529015-000	16/20 A	100-120 Vac 1ph	L5-20P 15 ft Cable	Half Rack		5-20 (18)		

## Optima™ 539 Series • 0U



Model Number	Current	Voltage	Inlet	Height	5-15 Outlets	5-20 Outlets	C13 Outlets	C19 Outlets
MPD 539002-000	24/30 A	120/208 Vac 3ph Wye	L21-30P 15 ft Cable	Full Rack			C13 (36)	C19 (6)
MPD 539004-000	24/30 A	120/208 Vac 3ph Wye	L21-30P 15 ft Cable	Full Rack		5-20 (36)		
MPD 539006-000	24/30 A	120/208 Vac 3ph Wye	L21-30P 15 ft Cable	Half Rack			C13 (18)	C19 (3)
MPD 539008-000	24/30 A	120/208 Vac 3ph Wye	L21-30P 15 ft Cable	Half Rack		5-20 (18)		

# Standard Product Comparison

## Optima™ 320 Series • 1U



Model Number	Current	Voltage	Inlet	5-15 Outlets	5-20 Outlets	C13 Outlets	C19 Outlets	Breakers	Meter
MPD 320001-000	12/15 A	120 Vac single phase	5-15P 9 ft Cable, Rear	5-15 (14)				none	
MPD 320002-000	12/15 A	120 Vac single phase	5-15P 9 ft Cable, Rear	5-15 (14)				(1) 15 A	
MPD 320003-000	16/20 A	120 Vac single phase	5-20P 9 ft Cable, Rear		5-20 (14)			(1) 20 A	
MPD 320004-000	16/20 A	100–240 Vac single phase	C20 Recessed, Rear			C13 (14)		(1) 20 A	
MPD 320005-000	12/15 A	120 Vac single phase	5-15P 9 ft Cable, Rear	5-15 (16)				(2) 15 A	
MPD 320006-000	24/30 A	120 Vac single phase	L5-30P 9 ft Cable, Rear		5-20 (16)			(2) 20 A	
MPD 320007-000	16/20 A	100–240 Vac single phase	C20 Recessed, Rear			C13 (20)		(2) 20 A	
MPD 320008-000	24/30 A	100–240 Vac single phase	L6-30P 9 ft Cable, Rear			C13 (12)	C19 (4)	(2) 20 A	
MPD 320009-000	12/15 A	120 Vac single phase	5-15P 9 ft Cable, Rear	5-15 (14)				(1) 15 A	Yes
MPD 320010-000	16/20 A	120 Vac single phase	5-20P 9 ft Cable, Rear		5-20 (14)			(1) 20 A	Yes
MPD 320011-000	16/20 A	100–240 Vac single phase	C20 Recessed, Rear			C13 (14)		(1) 20 A	Yes

## Optima™ 329 Series • 0U



Model Number	Current	Voltage	Inlet	5-15 Outlets	5-20 Outlets	C13 Outlets	C19 Outlets	Breakers	Meter
MPD 329001-000	16/20 A	120 Vac single phase	5-20P 9 ft Cable, Rear		5-20 (15)			(1) 20 A	Yes
MPD 329002-000	16/20 A	120 Vac single phase	C20 Recessed, Rear			C13 (12)	C19 (3)	(1) 20 A	Yes
MPD 329003-000	24/30 A	100–240 Vac single phase	L5-30P 9 ft Cable, Rear		5-20 (30)			(2) 20 A	Yes
MPD 329004-000	24/30 A	100–240 Vac single phase	L6-30P 9 ft Cable, Rear			C13 (24)	C19 (6)	(2) 20 A	Yes





# Optima™ RCM 820 Series

## Single-Phase 1U Networked PDUs

### A Feature-Filled Compact Package

The Optima 820 is a series of 1U PDUs for single-phase applications needing maximum capability in a small enclosure.

The system includes all the features of Marway's protective PDU infrastructure including surge suppressor, EMI filter, and main circuit breaker. Remote management tools include Marway's Commander EPO bus for hardware-based On/Off/EPO control, and our RCM software for Ethernet-based switching and power monitoring.

Several models cover a variety of power options, inlets, and outlets. Shared core features make it easy to standardize on a versatile platform, yet tailor each deployment to meet distinct power requirements.

### Feature Highlights

- Standard remote switching over Ethernet.
- Standard inlet power monitoring over Ethernet with local LED display and keypad (V, A, W, VA, VAR, PF, Hz).
- HTTP/S, Telnet, SSH, SNMP, SMTP, SNTP, IPv4.
- 1U chassis with removable/relocatable mounting brackets.
- 120 Vac, 200–240 Vac, or 100–240 Vac 1 $\phi$  power sources.
- 12 A, 16 A, or 24 A continuous-duty capacity (15 A, 20 A, or 30 A maximum capacity).
- 9 outlets (1 unswitched on front, 8 switched on back).
- 5-15R, 5-20R, or C13 outlet options.
- Standard 9 foot inlet cable with straight blade or locking inlet connectors, or C20 panel connector.
- Standard main power circuit breaker with On indicator.
- Standard surge suppression.
- Standard EMI filter.
- Standard remote EPO.
- Standard 18 gauge enclosure, black powder coated.
- Certified to UL 62368-1.

### Relevant Links

[Optima 820 web page](#)

[RCM Software documentation web page](#)

[All Optima 8 Series web page](#)

[Commander EPO Panels web page](#)

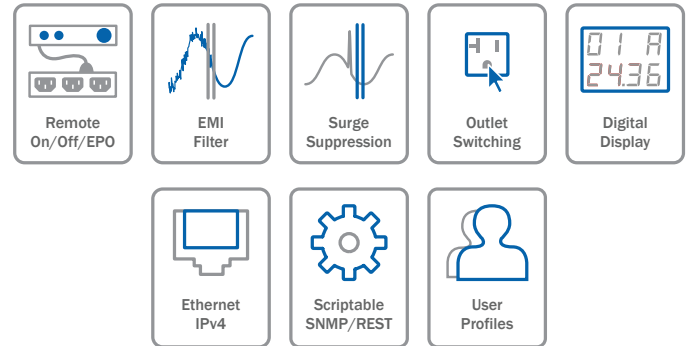

Several configurations offer options for outlet connectors, inlet connectors, and power range. The IEC outlets feature a unique, high-tension design providing similar pull-out resistance as NEMA outlets, thereby eliminating the need for proprietary locking systems or cumbersome retention clips. All models have surge suppression, EMI filter, and remote EPO panel connections.

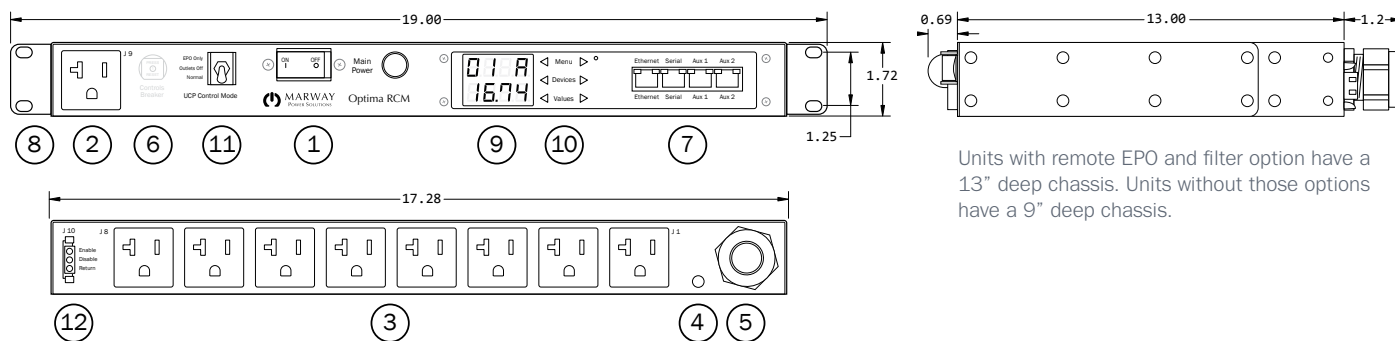

Units with remote EPO and filter option have a 13" deep chassis. Units without those options have a 9" deep chassis.

## Map of Features

### Standard Features

- (1) Main Power breaker and indicator. The breaker will have a 15, 20, or 30 A maximum-duty rating (de-rated to 80% for continuous duty). Indicator is amber. Whenever the main circuit breaker is On, the Powered indicator is illuminated to indicate that power is *available* to the switched outlets. Outlets themselves may not be on.
- (2) Front-panel unswitched outlet. This outlet is always powered when the main breaker is on—that is, it is never switched or disabled by EPO even when those options are included. Power is disabled when the main breaker is off.
- (3) Rear-panel switched outlets. These outlets are controlled by the RCM switching software. All outlets are disabled by remote EPO *when that option is included* (some older models had this as an option) and the software state is updated to reflect the off status of the outlets.
- (4) Threaded ground lug.
- (5) Power inlet. Most models include a strain-relieved cable as shown. The plug will vary by model. Some models include a panel-mounted C20 connector.
- (6) Circuit breaker for internal control circuitry. Units manufactured from early 2022 onward do not have this breaker. It was replaced with internal fuses.
- (7) Ethernet, RS-232 serial console, and auxiliary connections. All are RJ-45. Auxiliary connectors are for Marway Temperature/Humidity sensors.
- (8) Mounting brackets. May be mounted in one of three locations to yield a “flush,” recessed, or rear-facing position of the chassis relative to the rack’s mounting flanges. May also be removed for table top operation, or adaptation of end user’s own custom brackets.
- (9) Display when the power monitoring option is included (all “PSW” models). Displays volts, amps, watts, VA, VAR, power factor, and frequency. When item 9 is included, item 10 is also included. (Some older models had this as an option.)
- (10) Software Keypad used to navigate values available on the display.
- (11) Remote EPO mode switch. A three-position toggle provides manual control over the remote EPO mode. See “Remote EPO” on page SC-9 for a description.

## Specification Summary

### Inlet Voltage Options

- 120 Vac, 50/60 Hz, single phase
- 200–240 Vac, 50/60 Hz, single phase
- 100–240 Vac, 50/60 Hz, single phase
- All voltages are listed as nominal input sources.

### Current Capacity Options

- 12 A continuous load / 15 A maximum
- 16 A continuous load / 20 A maximum
- 24 A continuous load / 30 A maximum
- Based on NEC regulations, traditional load ratings are de-rated to 80% for continuous duty. For example, a traditional 30 A maximum rating is now interpreted and labeled as a 24 A continuous duty rating. Optima current ratings are shown with continuous/maximum rating values.

### Overload Protection (standard)

- All models include a two-pole UL 489 circuit breaker.
- 12/15 A models are wired with both line and neutral passing through the circuit breaker.
- 16/20 A models are wired with both line and neutral passing through the circuit breaker.
- 24/30 A models with 5-20 outlets use a 20 A breaker with the main line branched to each pole of the breaker (creating two 20 A sub-circuits).
- 24/30 A models with C13 outlets use a 15 A breaker with the main line branched to each pole of the breaker (creating two 15 A sub-circuits).

### Surge Suppression (standard)

- All models include a thermally protected varistor.
- 120 Vac models have a single-pulse energy rating of 100 joules.
- 240 Vac models have a single-pulse energy rating of 170 joules.
- All models have a peak surge current rating of 10,000 A for a single pulse 8x20µs wave.

### Environment

- Operating Temperature: 32°F to 122°F
- Maximum Altitude: 6,562 feet
- Relative Humidity: 5% to 85% non-condensing

### EMI Filter

- 120 Vac models have < 0.5 mA leakage.
- 240 Vac models have < 1.0 mA leakage.

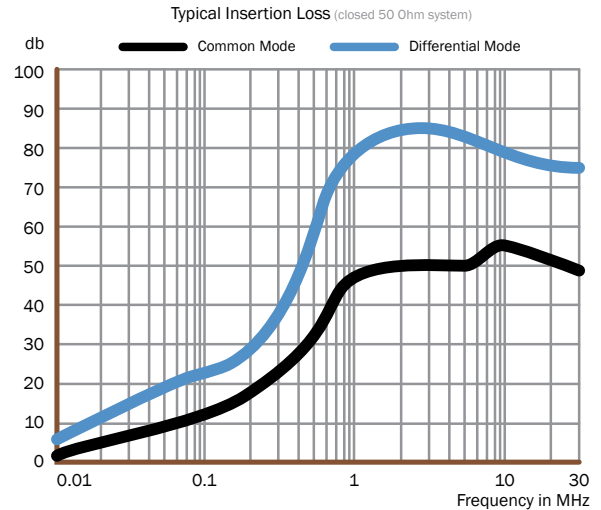

### Remote EPO

- Panel connector: AMP #1-480304-0, 250 Vac, 4 A maximum
- Mating cable connector: AMP #1-480305-0

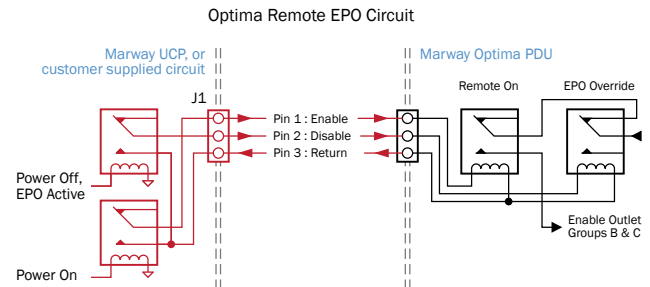

## Networking

### Ethernet 10/100T

- IPv4: DHCP, Static

### Web Interface

- HTTP, HTTPS

### Command Line Interface

- Telnet, SSH, RS-232

### SNMP

- v2/v3
- Access to power data, alarms, outlet switching

### Alerts

- Email over SMTP
- SMS over SMTP
- SNMP v2/v3 Traps

### Scriptability

- RESTful API
- Telnet/SSH
- SNMP

### Other Protocols

- SNMP, SNMP, FTP

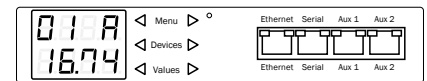

Ethernet = network connection  
 Serial = non-networked, console connection  
 Aux 1 and 2 = T/H Sensor 1 and 2

Optima RCM 820 Series PDUs

**MPD 820101-PSW-000 (N.O) / -001 (N.C.) / -002 (LT)**

Amps Max<sup>1</sup>  
**15**

NEMA Outlets  
**5-15**

1ph Vac  
**120**

Cable Inlet 9 ft  
**5-15P**

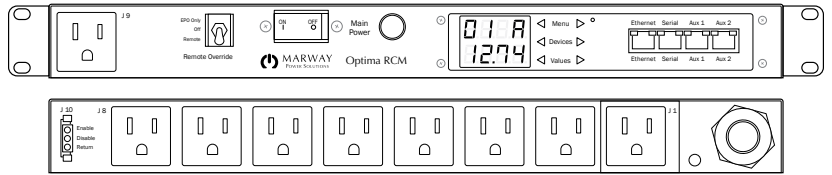

**MPD 820102-PSW-000 (N.O) / -001 (N.C.) / -002 (LT)**

Amps Max<sup>1</sup>  
**20**

NEMA Outlets  
**5-20**

1ph Vac  
**120**

Cable Inlet 9 ft  
**5-20P**

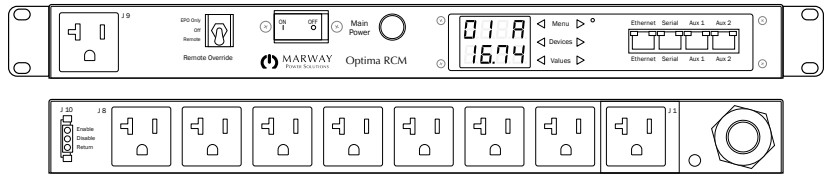

**MPD 820103-PSW-000 (N.O) / -001 (N.C.) / -002 (LT)**

Amps Max<sup>1</sup>  
**20**

NEMA Outlets  
**5-20**

1ph Vac  
**120**

Cable Inlet 9 ft  
**L5-20P**

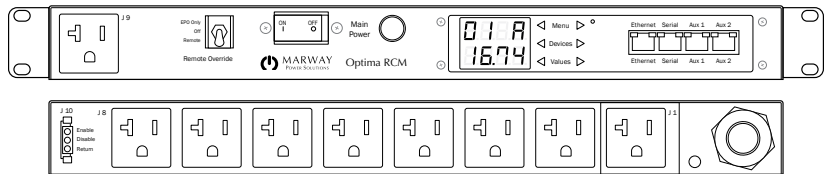

**MPD 820104-PSW-000 (N.O) / -001 (N.C.) / -002 (LT)**

Amps Max<sup>1</sup>  
**20**

IEC Outlets  
**C13**

1ph Vac  
**200-240**

Cable Inlet 9 ft  
**L6-20P**

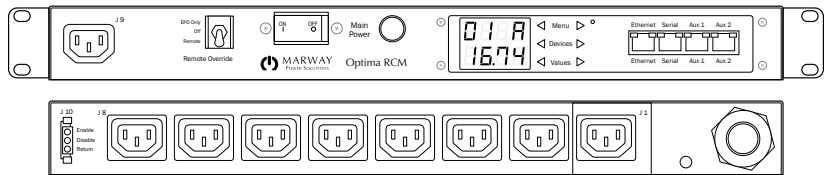

Cable is separate. Select from Power Cables options on next page.

[1] Continuous load duty rating is 80% of Amps Max.  
All Models – General chassis style shown. Details may vary. Specifications and availability subject to change without notice.

Optima RCM 820 Series PDUs

MPD 820105-PSW-000 (N.O) / -001 (N.C.) / -002 (LT)

Amps Max<sup>1</sup>  
**20**

NEMA Outlets  
**C13**

1ph Vac  
**100-240**

Panel Inlet  
**C20**

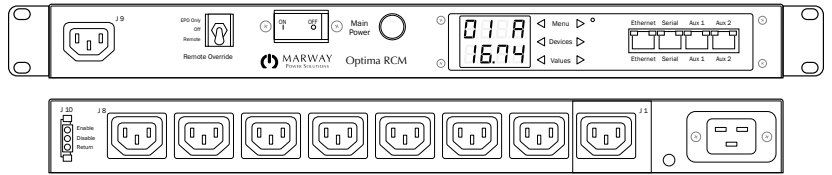

MPD 820107-PSW-000 (N.O) / -001 (N.C.) / -002 (LT)

Amps Max<sup>1</sup>  
**30**

NEMA Outlets  
**5-20**

1ph Vac  
**120**

Cable Inlet 9 ft  
**L5-30P**

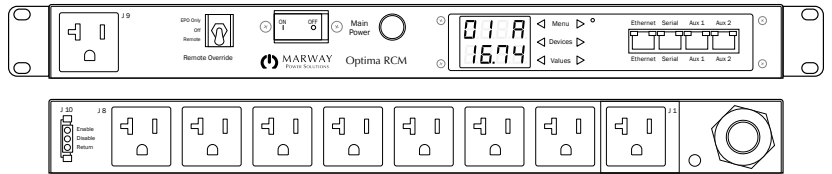

MPD 820108-PSW-000 (N.O) / -001 (N.C.) / -002 (LT)

Amps Max<sup>1</sup>  
**30**

NEMA Outlets  
**C13**

1ph Vac  
**200-240**

Cable Inlet 9 ft  
**L6-30P**

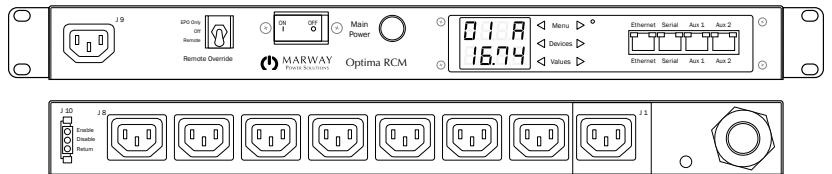

[1] Continuous load duty rating is 80% of Amps Max.

All Models – General chassis style shown. Details may vary. Specifications and availability subject to change without notice.

## Power Cables

Power cables for models which have the C20 panel connector.

Part Number	PDU	Facility	Length
311114-001	C19	C20	8 feet
311114-002	C19	L6-20P	8 feet
311114-003	C19	6-20P	8 feet
311114-004	C19	L5-20P	8 feet
311114-005	C19	5-20P	8 feet
311114-000	C19	Wire Leads	8 feet

## Cable Bracket

Steel bracket, powder coated black. Fits onto the back of any Optima 320, 520, or 820. Adds approximately 3.5" to the back of the PDU.

Part Number 113286-000

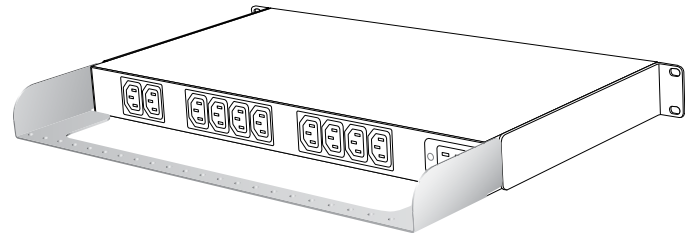

## Remote Bus Cables

These cables are for the Remote Control Bus.

Part Number	PDU Connector	Cable Connector A	Cable Connector B	Remote Connector	Length
400075-120	AMP 1-480304-0	AMP 1-480305-0	AMP 1-480305-0	AMP 1-480304-0	10 feet
400062-120	AMP 1-480304-0	AMP 1-480305-0	Molex 03-09-3032	Molex 03-09-1081	10 feet

## Serial Cable (USB to RJ45)

This cable is required for initial on-site setup of the PDU software. See "Getting Started" in the User Guide.

Part Number	PDU Connector	Computer Connector	Length
311118-000	RJ45	USB Type A	6 feet



# Optima™ 833 Series

## Three-Phase 3U Networked PDUs

### Maximum Connectivity and Flexibility

With 5 or 6 individually breakered circuits, and 17 or 18 outlets, the 833 offers the highest power management flexibility of the Optima 8 Series products. With standard surge suppressor, EMI filter, and remote EPO, this 3-phase, 30-amp unit provides a high density solution ready for industrial environments.

### Shared Feature Highlights

- Standard remote switching over Ethernet.
- Standard inlet power monitoring over Ethernet with local LED display and keypad.
- HTTP/S, Telnet, SSH, SNMP, SMTP, SNTP, IPv4
- 120/208 Vac 3 $\phi$  wye, 50/60 Hz, 24/30 A, L21-30P inlet.
- Inlet available on rear panel or front panel. The front panel inlet connector can be either a recessed male or a strain-relieved cable. The rear panel inlet connector is always a strain-relieved cable. Cables are 9 feet with an L21-30 plug.
- Standard main power four-pole circuit breaker with a power-on indicator for each phase.
- Standard surge suppression and EMI filter.
- Standard remote EPO interface.
- Standard 16/20 A utility circuit with one 5-20R duplex (breakered, but not switched or subject to the EPO system).
- One set of models includes sixteen 5-20R outlets grouped into four 16/20 A circuits each having four outlets. These models do not include additional twist-lock connectors.
- Another set of models includes twelve 5-20R outlets grouped into three 16/20 A circuits each having four outlets. These models also have three twist-lock connectors:
  - Two 16/20 A circuits each with a switched twist-lock outlet. Both circuits have the same twist-lock type with a choice of L5-20R, L5-30R, L6-20R, or L6-30R.
  - One 24/30 A pass-through outlet off the main breaker with one switched L21-30R connector.
- Designed and manufactured to UL 62368-1.

### Documentation and Related Links

[Optima 833 web page](#)

[RCM Software documentation web page](#)

[All Optima 8 Series web page](#)

[Commander EPO Panels web page](#)

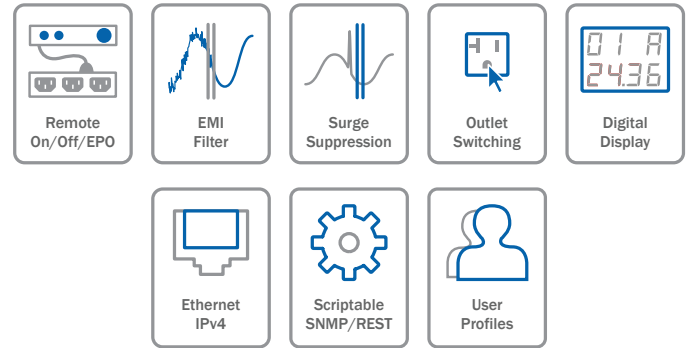

There are 10 configurations of 833 models allowing for the inlet to be on the front or rear panel, and a variety of connectors. There are two general configurations with one set of models including all 5-20R outlets (upper), and another set of models including three twist lock connectors (lower). All models have 30 amp, 3-phase wye inputs.

## Specification Summary

### Inlet Voltage and Current

- All models 120/208 Vac, 50/60 Hz, three-phase wye
- All models 24 A continuous load / 30 A maximum

### Overload Protection (standard)

- All models include a four-pole main circuit breaker wired with all three phases and neutral passing through the breaker.
- All branch breakers are UL 489, 16 A continuous load / 20 A max.
- Based on NEC regulations, traditional load ratings are de-rated to 80% for continuous duty. For example, a traditional 30 A maximum rating is now interpreted and labeled as a 24 A continuous duty rating. Optima current ratings are shown with continuous/maximum rating values.

### Surge Suppression (standard)

- All models include a thermally protected varistor on each phase with a single-pulse energy rating of 120 joules
- All models have a peak surge current rating of 10,000 A for a single pulse 8x20µs wave.

### Environment

- Operating Temperature: 32 °F to 122 °F
- Maximum Altitude: 6,562 feet
- Relative Humidity: 5% to 85% non-condensing

### EMI Filter (standard)

- All models have < 1.0 mA leakage.

### Typical Insertion Loss (closed 50 Ohm system)

Frequency (MHz)	0.15	0.5	1	10	30
Common Mode (dB)	55	62	65	50	45
Differential Mode (dB)	36	55	60	60	50

### Remote EPO (standard)

- Panel connector: AMP #1-480304-0, 250 Vac, 4 A maximum.
- Mating cable connector: AMP #1-480305-0.
- Connectors J20, J21, J22 are wired in parallel. J23 has enable delay.
- All outlets other than J1 are managed by the Remote Control Bus.
- J1 outlets (and J9 if present) are always powered relative to the Main Breaker state.

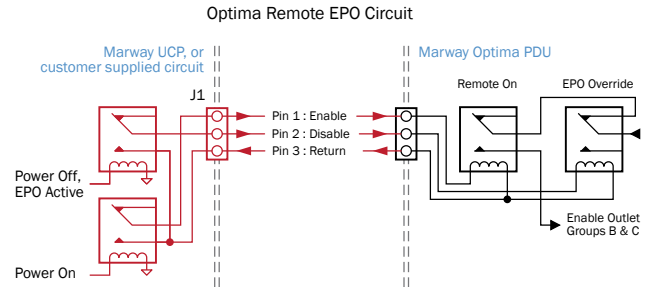

## Networking

### Ethernet 10/100T

- IPv4: DHCP, Static

### Web Interface

- HTTP, HTTPS

### Command Line Interface

- Telnet, SSH, RS-232

### SNMP

- v2/v3
- Access to power data, alarms, outlet switching

### Alerts

- Email over SMTP
- SMS over SMTP
- SNMP v2/v3 Traps

### Scriptability

- RESTful API
- Telnet/SSH
- SNMP

### Other Protocols

- SNMP, FTP

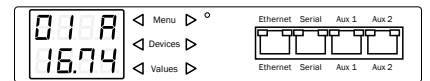

Ethernet = network connection  
 Serial = non-networked, console connection  
 Aux 1 and 2 = T/H Sensor 1 and 2



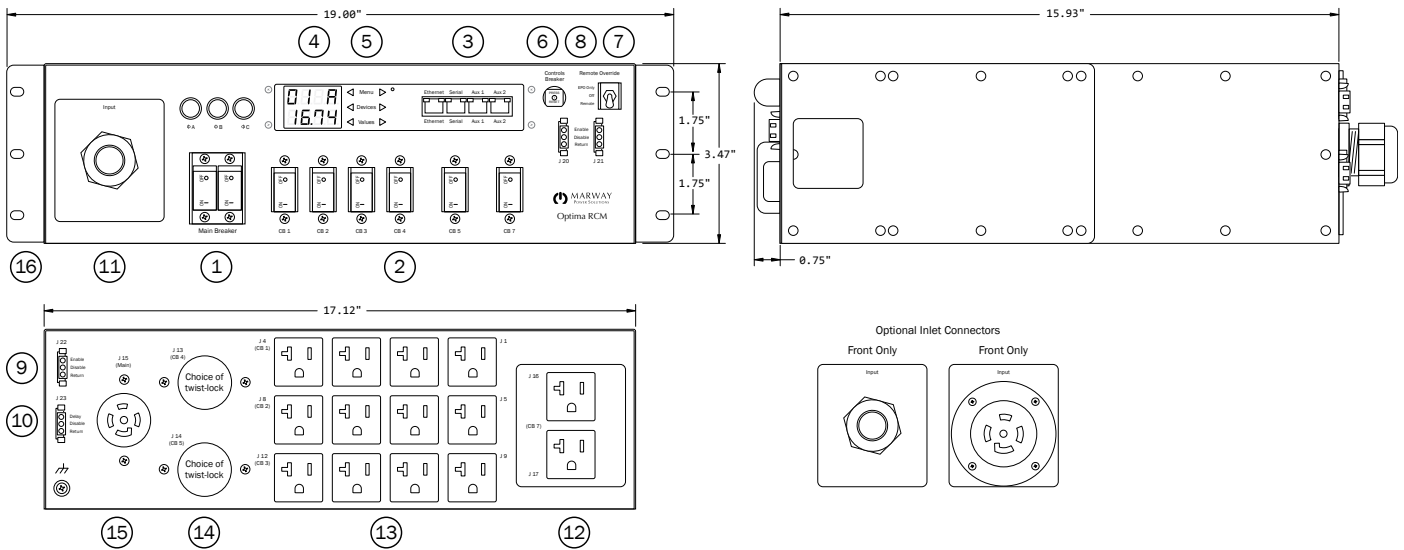

## 833 Series Map of Features

### Standard Features

- (1) Main 24/30 A breaker and phase-power indicators.
- (2) Branch 16/20 A circuit breakers for outlets. Some models have 5, some models have 6.
- (3) Ethernet, RS-232 serial console, and auxiliary connections. All are RJ-45. Auxiliary connectors are for Marway Temperature/Humidity sensors.
- (4) Digital display of inlet power data and relay state.
- (5) Display navigation keypad.
- (6) Internal controls 1 A, push-type breaker.
- (7) Remote EPO mode switch. A three-position toggle provides manual control over the remote EPO mode.
- (8) Front panel remote EPO control bus interface. Two connectors enable the PDU to be daisy chained between a remote EPO panel (such as Marway’s UCP) and another PDU, or between two PDUs.
- (8) Front panel remote EPO interface (two connectors).
- (9) Rear panel remote EPO interface. A third connector for when a rear connection is more convenient.
- (10) Rear panel remote EPO delay interface. When the Enable signal of a remote panel is triggered, the signal is propagated immediately to all downstream devices through the connectors J20, J21, and J22. Connector J23 introduces a delay of 2 seconds before forwarding the Enable signal. By daisy chaining PDUs with the delay connectors, a staggered start can be created between each downstream PDU.

- (16) Mounting brackets. May be mounted to yield a “flush,” front-recessed, rear-facing, or rear-recessed position of the chassis relative to the rack’s mounting flanges. The brackets include a cutout to allow an inlet cable to be directed into the interior of the rack when the brackets are mounted for a recessed-chassis position. The brackets may also be removed for table top operation, or adaptation of the end user’s own brackets.

### Optional Configurations

- (11) Power inlet. Some models include a strain-relieved 9-foot cable with an L21-30 plug on the rear panel. Some models include a recessed male connector on the front panel.
- (12) A pair of unswitched 5-20R outlets are standard on all models. The location of these outlets and the Inlet connector (11) are swapped on some models.
- (13) All models include at least twelve 5-20R switched outlets (J1 through J12).
- (14) On some models, J13 and J14 are twist lock connectors with a choice of L5-20, L5-30, L6-20, or L6-30 where both are the same. On other models, these two twist locks are replaced by four switched 5-20R outlets (for a total of 16 switched 5-20R outlets).
- (15) Models which include twist locks for J13 and J14 will also include J15 which is always an L21-30 providing pass-through power from the main breaker.

Optima RCM 833 Series PDUs

Front Inlet: MPD 833xxx-PSW-000 (N.O) / -001 (N.C.) / -002 (LT)

Amps Max<sup>1</sup>  
**30**

NEMA Outlets  
**(see table)**

3ph Vac Wye  
**120/208**

Panel Inlet  
**L21-30P**

Model Number	Inlet	J5, J6 Outlets	J8 Outlet
MPD 833005-PSW-000	L21-30P	5-20R, 120V	None
MPD 833006-PSW-000	L21-30P	L5-20R, 120V	L21-30R
MPD 833007-PSW-000	L21-30P	L5-30R, 120V	L21-30R
MPD 833008-PSW-000	L21-30P	L6-20R, 208V	L21-30R
MPD 833009-PSW-000	L21-30P	L6-30R, 208V	L21-30R

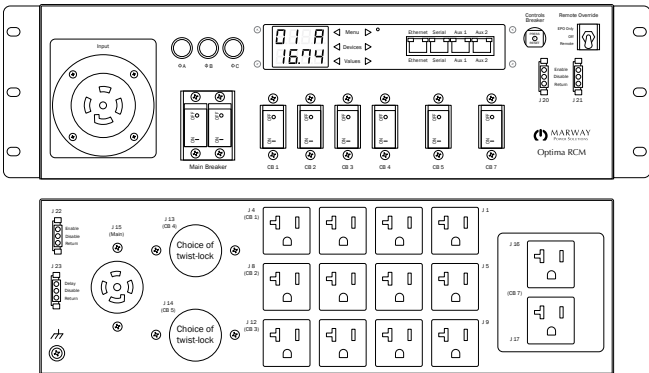
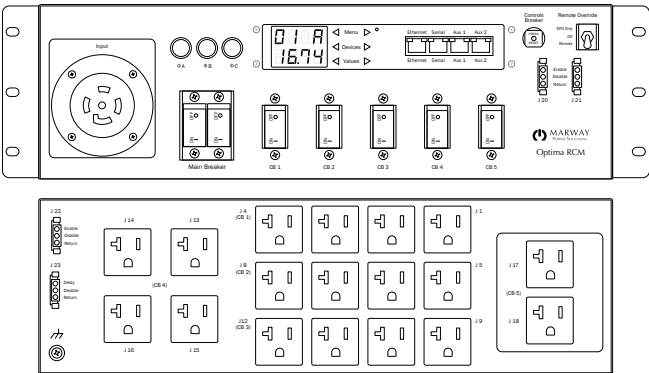

Rear Inlet: MPD 833xxx-PSW-000 (N.O) / -001 (N.C.) / -002 (LT)

Amps Max<sup>1</sup>  
**30**

NEMA Outlets  
**(see table)**

3ph Vac Wye  
**120/208**

Cable Inlet 9 ft  
**L21-30P**

Model Number	Inlet	J5, J6 Outlets	J8 Outlet
MPD 833010-PSW-000	L21-30P / 9 ft.	5-20R, 120V	None
MPD 833011-PSW-000	L21-30P / 9 ft.	L5-20R, 120V	L21-30R
MPD 833012-PSW-000	L21-30P / 9 ft.	L5-30R, 120V	L21-30R
MPD 833013-PSW-000	L21-30P / 9 ft.	L6-20R, 208V	L21-30R
MPD 833014-PSW-000	L21-30P / 9 ft.	L6-30R, 208V	L21-30R

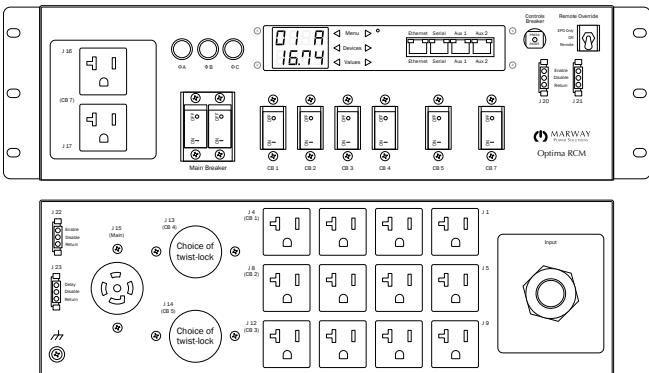
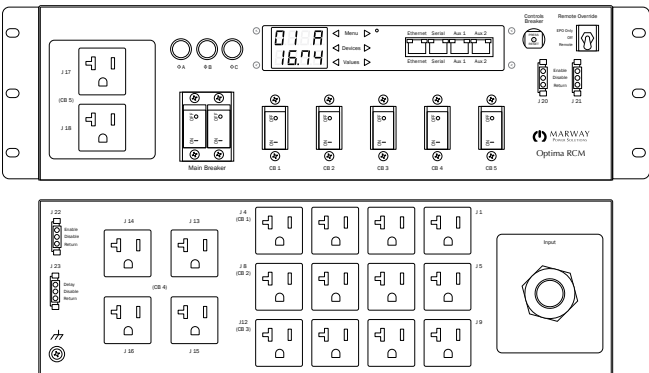

[1] Continuous load duty rating is 80% of Amps Max.  
All Models – General chassis style shown. Details may vary. Specifications and availability subject to change without notice.

# Optima RCM 833 Series PDUs

## Remote Bus Cables

These cables are for the Remote Control Bus.

Part Number	PDU Connector	Cable Connector A	Cable Connector B	Remote Connector	Length
400075-120	AMP 1-480304-0	AMP 1-480305-0	AMP 1-480305-0	AMP 1-480304-0	10 feet
400062-120	AMP 1-480304-0	AMP 1-480305-0	Molex 03-09-3032	Molex 03-09-1081	10 feet

## Serial Cable (USB to RJ45)

This cable is required for initial on-site setup of the PDU software.  
See "Getting Started" in the User Guide.

Part Number	PDU Connector	Computer Connector	Length
311118-000	RJ45	USB Type A	6 feet



# Optima™ 829 Series

## Single-Phase 0U Networked PDUs

### Space Saving Vertical Installation

A vertical PDU frees up rack space for more application equipment, though the narrow size means leaving out some features of the other Optima models. Each has 24 switched outlets with either a 20 A or 30 A inlet. The 829 Series offers a high count of switched relays in a space-saving and cost-effective design well-suited to many applications.

### Feature Highlights

- Standard remote switching over Ethernet.
- Standard remote inlet power monitoring over Ethernet with local LED display and keypad.
- HTTP/S, Telnet, SSH, SNMP, SMTP, SNTP, IPv4
- 0U chassis in full-rack (72”).
- End, side, and tool-less mounting options.
- Multiple inlet power options including:
  - 120 Vac single phase, 50/60 Hz, 16/20 A
  - 110-240 Vac single phase, 50/60 Hz, 16/20 A
  - 200-240 Vac single phase, 50/60 Hz, 24/20 A
  - 200-240 Vac single phase, 50/60 Hz, 24/30 A
- Standard UL 489 circuit breakers with power on indicators.
- Inlet connector types including:
  - 5-20P, L5-20P
  - L6-20P, L6-30P
  - C20 chassis, and C20 cable
- Outlet connector types including:
  - All 5-20R, Mixed C13, and C19.
- Designed and manufactured to UL 62368-1.

### Relevant Links

[Optima 829 web page](#)

[RCM Software documentation web page](#)

[All Optima 8 Series web page](#)

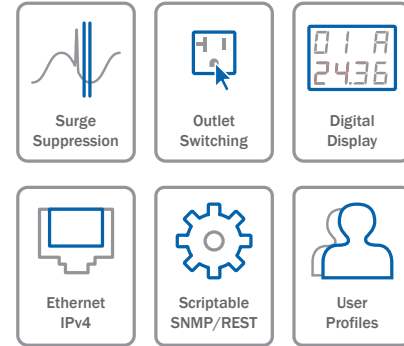

# Optima RCM 829 Series PDUs

## Specification Summary

### Inlet Voltage Options

- 120 Vac, 50/60 Hz, single phase
- 110-240 Vac, 50/60 Hz, single phase
- 200-240 Vac, 50/60 Hz, single phase
- All voltages are listed as nominal input sources.

### Current Capacity Options

- 16 A continuous load / 20 A maximum
- 24 A continuous load / 30 A maximum
- Based on NEC regulations, traditional load ratings are de-rated to 80% for continuous duty. For example, a traditional 30 A maximum rating is now interpreted and labeled as a 24 A continuous duty rating. Optima current ratings are shown with continuous/maximum rating values.

### Overload Protection (standard)

- All models include UL 489 two-pole circuit breakers.
- All single-phase models are wired with both line and neutral passing through the two-pole circuit breaker.
- All multi-breaker models are wired with a group of eight of outlets per breaker.

### Environment

- Operating Temperature: 32° F to 122° F
- Maximum Altitude: 6,562 feet
- Relative Humidity: 5% to 85% non-condensing

## Networking

### Ethernet 10/100T

- IPv4: DHCP, Static

### Web Interface

- HTTP, HTTPS

### Command Line Interface

- Telnet, SSH, RS-232

### SNMP

- v2/v3
- Access to power data, alarms, outlet switching

### Alerts

- Email over SMTP
- SMS over SMTP
- SNMP v2/v3 Traps

### Scriptability

- RESTful API
- Telnet/SSH
- SNMP

### Other Protocols

- SNMP, SNMP, FTP

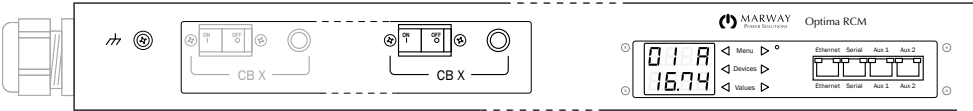
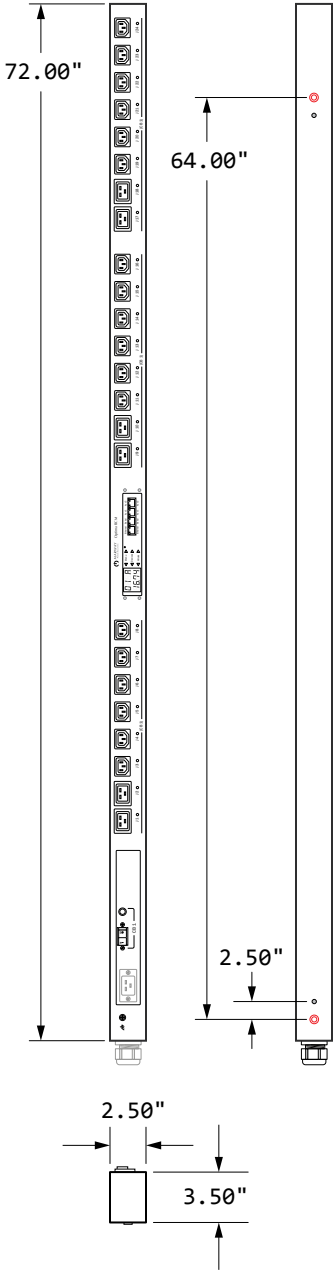

Your model may have 1 to 3 branch breakers.  
Your model may have a cable inlet strain relief, or a C20 panel connector.

Your model may or may not have a power meter.  
Ethernet = network connection  
Serial = non-networked, console connection  
Aux 1 and 2 = T/H Sensor 1 and 2

Optima RCM 829 Series PDUs

**MPD 829001-PSW-000**

Amps Max<sup>1</sup> **20**      1ph Vac **100-240**      Inlet Connector **C20**      Circuits **1 @ 20A**      IEC Outlets **C13 (18)**      **C19 (6)**



**MPD 829003-PSW-000**

Amps Max<sup>1</sup> **20**      1ph Vac **200-240**      Inlet Cable 15 ft **L6-20P**      Circuits **1 @ 20A**      IEC Outlets **C13 (18)**      **C19 (6)**

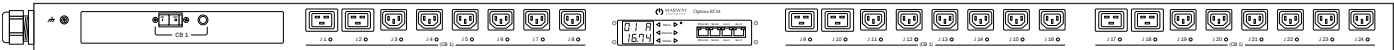

**MPD 829004-PSW-000**

Amps Max<sup>1</sup> **30**      1ph Vac **200-240**      Inlet Cable 15 ft **L6-30P**      Circuits **3 @ 20A**      IEC Outlets **C13 (18)**      **C19 (6)**



**MPD 829006-PSW-000**

Amps Max<sup>1</sup> **20**      1ph Vac **120**      Inlet Cable 15 ft **5-20P**      Circuits **1 @ 20A**      NEMA Outlets **5-20 (24)**



**MPD 829007-PSW-000**

Amps Max<sup>1</sup> **20**      1ph Vac **120**      Inlet Cable 15 ft **L5-20P**      Circuits **1 @ 20A**      NEMA Outlets **5-20 (24)**



[1] Continuous load duty rating is 80% of Amps Max.  
All Models – General chassis style shown. Details may vary. Specifications and availability subject to change without notice.

## Power Cables

Power cables for models which have the C20 panel connector.

Part Number	PDU	Facility	Length
311114-001	C19	C20	8 feet
311114-002	C19	L6-20P	8 feet
311114-003	C19	6-20P	8 feet
311114-004	C19	L5-20P	8 feet
311114-005	C19	5-20P	8 feet
311114-000	C19	Wire Leads	8 feet

## Serial Cable (USB to RJ45)

This cable is required for initial on-site setup of the PDU software.  
See “Getting Started” in the User Guide.

Part Number	PDU Connector	Computer Connector	Length
311118-000	RJ45	USB Type A	6 feet

[1] Continuous load duty rating is 80% of Amps Max.

All Models – General chassis style shown. Details may vary. Specifications and availability subject to change without notice.



# RCM™ MES 802

PSU Development Simulator for Remote Control and Monitoring

## Develop Scripts Without a PDU

The RCM development simulator enables developers of remote power control and monitoring software to test code against a working RCM instance. This enables development of code for outlet control, power monitoring, alert notifications, provisioning, and doing pre-deployment testing of TLS certificates, and more. Having a simulator means this work can be done without taking a PDU out of commission, or without a full-sized PDU occupying the developer's workspace.

### Feature Highlights

- Runs actual RCM firmware on actual RCM hardware.
- Only power data and switching behavior is simulated.
- Enables testing of all network APIs (SNMP, REST, Telnet, ssh, serial, SMTP alarms, and more).
- Ethernet, serial, and temperature/humidity ports are all fully functional.
- Small footprint of approximately 9" x 4" (3.6" high).

Software documentation available at  
<http://www.marway.com/docs/rcm>

## RCM Development Kit

Part Number	RCM Version
MES 802-000	2.x



Simulator enclosure comes with power adaptor and USB to RJ45 serial cable for setup, and using the serial console command line interface.





# Optima™ 520 Series

## Single-Phase 1U Basic PDUs

### A Feature-Filled Compact Package

The 520 Series packs 12 outlets, a digital power meter, remote On/Off/EPO interface, surge suppressor, EMI filter, and outlet sequencing into a 1U chassis. There are six models offering a variety of inlet and outlet connectors, input voltages, and current capacities.

### Feature Highlights

- 1U chassis with removable/relocatable mounting brackets.
- 12 outlets (2 on front, 10 on back).
- 120 Vac, 200–240 Vac, or 110–240 Vac 1 $\phi$  power sources.
- 12 A, 16 A, or 24 A continuous-duty capacity (15 A, 20 A, or 30 A maximum capacity).
- 5-15R, 5-20R, or high-tension C13 outlets.
- Straight blade or locking inlet connectors.
- Standard main power circuit breaker with On indicator.
- Standard surge suppression.
- Standard multi-function current and voltage meter.
- Standard remote switching / remote EPO interface.
- Standard sequencing of outlets (two groups of four outlets).
- Standard EMI filter.
- Certified to UL 62368-1.

### Relevant Links

[Optima 520 web page](#)

[All Optima 5 Series web page](#)

[Commander EPO Panels web page](#)

[Optima 520 Operating Guide](#)

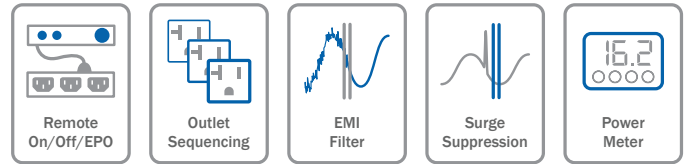

Six configurations provide options for outlet connectors, inlet connectors, and power capacity. All models include power conditioning and remote control features. IEC outlets feature a high-tension design providing similar pull-out resistance as NEMA outlets, thereby eliminating the need for proprietary locking systems or cumbersome retention clips.

# Optima 520 Series PDUs

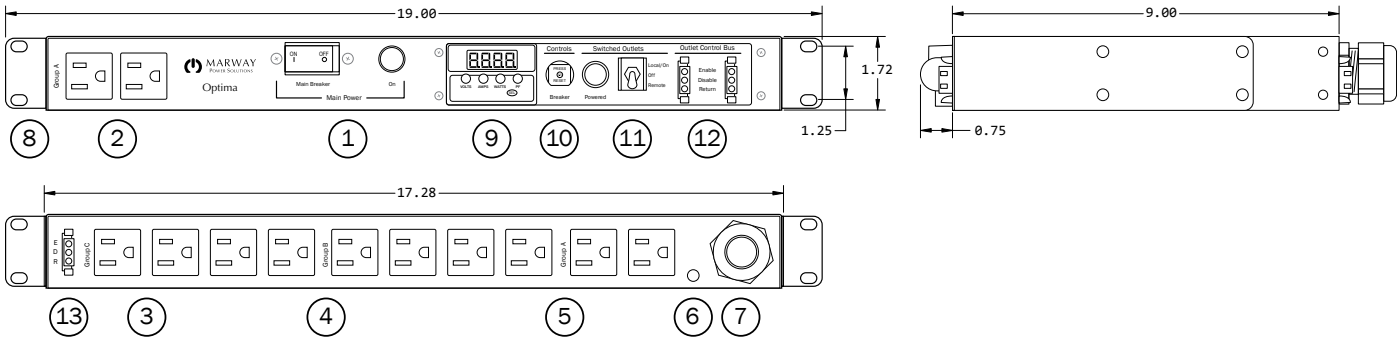

## Map of Features

- (1) Main Power breaker and indicator. The breaker will have a 15, 20, or 30 A maximum-duty rating (de-rated to 80% for continuous duty). Indicator is amber.
- (2) Front-panel Group A outlets. These outlets are always powered—that is, they are never switched or sequenced.
- (3) Rear-panel Group A outlets. These outlets are always powered—that is, they are never switched or sequenced.
- (4) Rear panel Group B outlets. These outlets are controlled by remote switching/EPO. Otherwise, they are always powered like Group A. The sequencing feature powers all four Group B outlets together about 2 seconds before Group C outlets.
- (5) Rear panel Group C outlets. These outlets are controlled by remote switching/EPO. Otherwise, they are always powered like Group A. When switched on, these outlets are powered 2 seconds after Group B.
- (6) Threaded ground lug.
- (7) Power inlet. Most models include a strain-relieved cable as shown. The plug will vary by model. Some models include a panel-mounted C20 connector.
- (8) Mounting brackets. May be mounted in one of three locations to yield a “flush,” recessed, or rear-facing position of the chassis relative to the rack’s mounting flanges. May also be removed for table top operation, or adaptation of end user’s own custom brackets.
- (9) Power meter can display volts, amperes, watts, and power factor.
- (10) Circuit breaker for internal control circuitry.
- (11) Remote Switching/EPO mode switch and indicator. The remote switching package includes items 10, 11, 12, and 13. The three-position toggle provides manual control over the remote switching mode. When Local/On, all outlets are powered, and only remote EPO will have impact. When Off, Groups B and C outlets are disabled, and any remote circuit will have no impact. When Remote, Groups B and C outlets are subject to the remote/EPO control bus. Group A outlets are always powered regardless of remote mode. Whenever the main circuit breaker is On, the Powered indicator is illuminated to indicate that power is *available* to the switched outlets.
- (12) Front panel Remote Switching/EPO control bus interface. Two connectors allow the PDU to be daisy chained between a Remote EPO panel (such as Marway’s UCP) and another PDU, or even between two PDU’s (when one of the others is connected to a remote EPO panel). Either connector can be used for either connection.
- (13) Rear panel Remote Switching/EPO control bus interface. This is a third connector provided for when a rear connection is more convenient.

# Specification Summary

### Inlet Voltage Options

- 120 Vac, 50/60 Hz, single phase
- 200–240 Vac, 50/60 Hz, single phase
- 110–240 Vac, 50/60 Hz, single phase
- All voltages are listed as nominal input sources.

### Current Capacity Options

- 12 A continuous load / 15 A maximum
- 16 A continuous load / 20 A maximum
- 24 A continuous load / 30 A maximum
- Based on NEC regulations, traditional load ratings are de-rated to 80% for continuous duty. For example, a traditional 30 A maximum rating is now interpreted and labeled as a 24 A continuous duty rating. Optima 5 current ratings are shown with continuous/maximum rating values.

### Overload Protection

- All models include a two-pole UL 489 circuit breaker.
- 12/15 A models are wired with both line and neutral passing through the circuit breaker.
- 16/20 A models are wired with both line and neutral passing through the circuit breaker.
- MPD 520084-00X uses a 20 A breaker with the main line branched to each pole of the breaker (creating two 20 A sub-circuits).
- MPD 520096-00X uses a 15 A breaker with the main line branched to each pole of the breaker (creating two 15 A sub-circuits).

### Surge Suppression

- All models include a thermally protected varistor.
- 120 Vac models have a single-pulse energy rating of 100 joules.
- 240 Vac models have a single-pulse energy rating of 170 joules.
- All models have a peak surge current rating of 10,000 A for a single pulse 8x20µs wave.

### Outlet Sequencing

- Group A outlets are powered at startup (regardless of remote state, or Switched Outlets switch position).
- Group B outlets are powered upon Remote Power On (or Switched Outlets switched to Local/On).
- Group C outlets are powered about 2 seconds after Group B.

### Environment

- Operating Temperature: 32 °F to 122 °F
- Maximum Altitude: 6,562 feet
- Relative Humidity: 5% to 85% non-condensing

### Power Meter

Display Value	Min	Max	Accuracy
Voltage (volts RMS)	85.0	264.0	± 1%
Current (amperes RMS)	0.00	32.00	± 1%
Active Power (watts RMS)	0.0	9999	± 2%
Power Factor	0.00	1.00	± 3%
Sample Rate (per second)	2	3	—

### EMI Filter

- 120 Vac models have < 0.5 mA leakage.
- 240 Vac models have < 1.0 mA leakage.

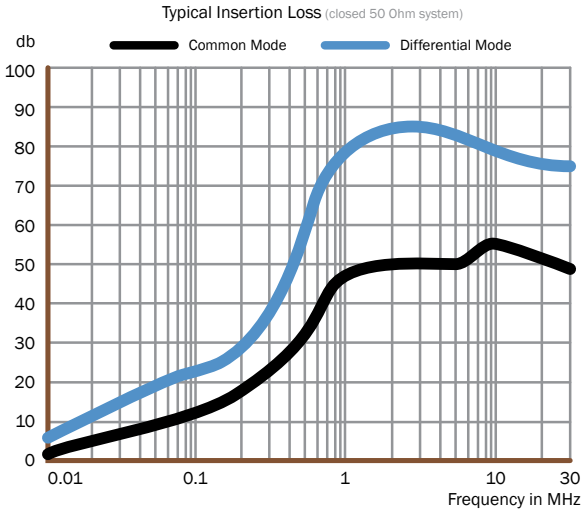

### Remote Switching/EPO

- Panel connector: AMP #1-480304-0, 250 Vac, 4 A maximum
- Mating cable connector: AMP #1-480305-0
- All three bus connectors (2 front, 1 rear) are wired in parallel.
- Group A outlets (2 front, 2 rear) are always powered.
- Groups B and C outlets are managed by the Remote Control Bus.

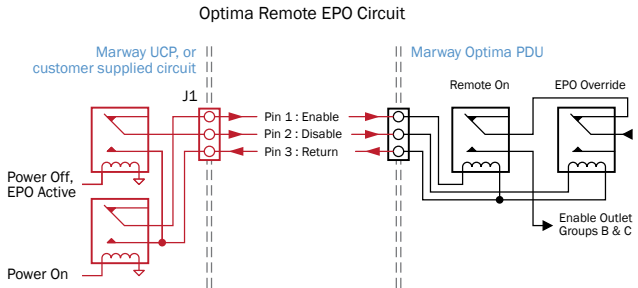

Optima 520 Series PDUs

MPD 520012-000 (N.O) / -001 (N.C.)

Amps Max<sup>1</sup>  
**15**

NEMA Outlets  
**5-15**

1ph Vac  
**120**

Cable Inlet 9 ft  
**5-15P**

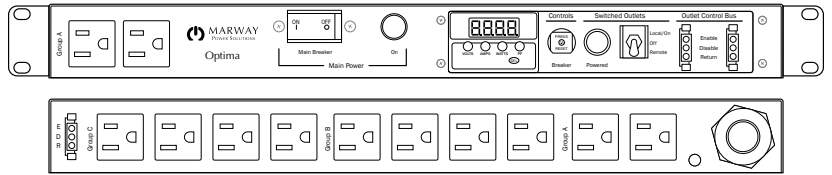

MPD 520024-000 (N.O) / -001 (N.C.)

Amps Max<sup>1</sup>  
**20**

NEMA Outlets  
**5-20**

1ph Vac  
**120**

Cable Inlet 9 ft  
**5-20P**

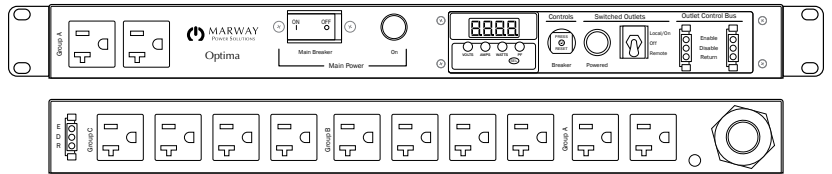

MPD 520036-000 (N.O) / -001 (N.C.)

Amps Max<sup>1</sup>  
**20**

NEMA Outlets  
**5-20**

1ph Vac  
**120**

Cable Inlet 9 ft  
**L5-20P**

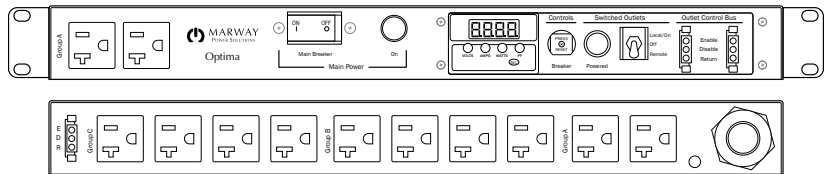

MPD 520060-000 (N.O) / -001 (N.C.)

Amps Max<sup>1</sup>  
**20**

IEC Outlets  
**C13**

1ph Vac  
**110-240**

Panel Inlet  
**C20**

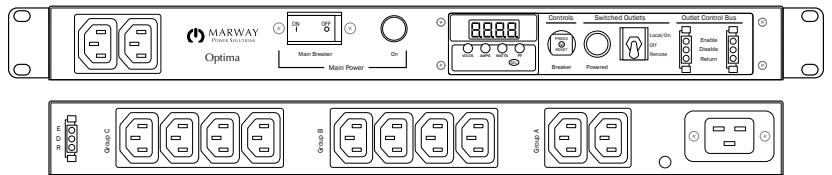

Cable is separate. Select from Power Cables options on next page.

[1] Continuous load duty rating is 80% of Amps Max.  
All Models – General chassis style shown. Details may vary. Specifications and availability subject to change without notice.

# Optima 520 Series PDUs

## MPD 520084-000 (N.O) / -001 (N.C.)

Amps Max<sup>1</sup>  
**30** NEMA Outlets  
**5-20**

1ph Vac  
**120** Cable Inlet 9 ft  
**L5-30P**

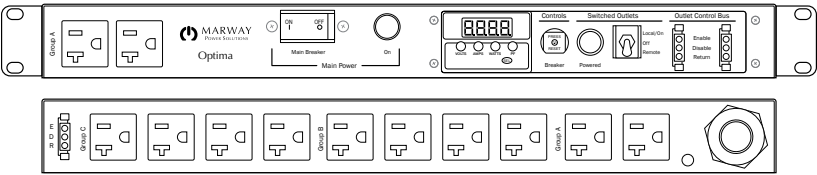

## MPD 520096-000 (N.O) / -001 (N.C.)

Amps Max<sup>1</sup>  
**30** IEC Outlets  
**C13**

1ph Vac  
**200-240** Cable Inlet 9 ft  
**L6-30P**

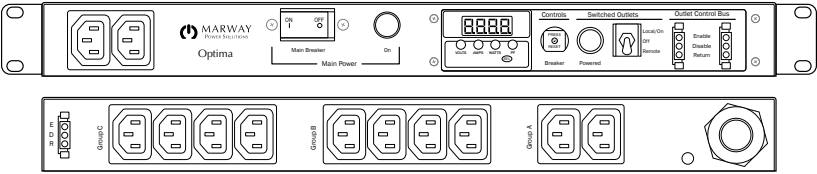

## Power Cables

These power cables are for PDUs which have the recessed, male C20 connector.

Part Number	PDU End	Facility End	Length
311114-001	C19	C20	8 feet
311114-002	C19	L6-20P	8 feet
311114-003	C19	6-20P	8 feet
311114-004	C19	L5-20P	8 feet
311114-005	C19	5-20P	8 feet
311114-000	C19	Wire Leads	8 feet

## Cable Bracket

Steel bracket, powder coated black. Fits onto the back of any Optima 320, 520, or 820. Adds approximately 3.5" to the back of the PDU.

Part Number 113286-000

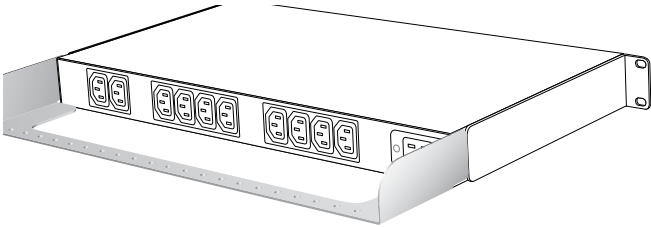

## Remote Bus Cables

These cables are for the Remote Control Bus.

Part Number	PDU Connector	Cable Connector A	Cable Connector B	Remote Connector	Length
400075-120	AMP 1-480304-0	AMP 1-480305-0	AMP 1-480305-0	AMP 1-480304-0	10 feet
400062-120	AMP 1-480304-0	AMP 1-480305-0	Molex 03-09-3032	Molex 03-09-1081	10 feet

[1] Continuous load duty rating is 80% of Amps Max.  
All Models – General chassis style shown. Details may vary. Specifications and availability subject to change without notice.



# Optima™ 532 Series

Three-Phase 2U Basic PDUs

## Compact 3-Phase Power

A 2U chassis and 3-phase inlet provides the space and power for four individually breakered circuits. Each circuit includes straight-blade and twist-lock outlets ready for diverse downstream equipment. With standard surge suppressor, EMI filter, and remote EPO interface, this 3-phase, 30-amp unit provides a compact solution for industrial environments.

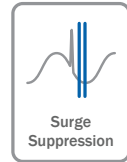
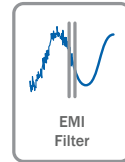
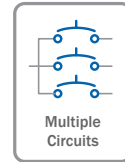
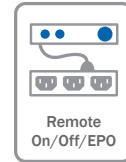

## Feature Highlights

- 2U chassis with removable/relocatable mounting brackets.
- 120/208 Vac 3 $\phi$  wye, 50/60 Hz, 24 A continuous duty (30 A maximum), L21-30P inlet.
- Inlet available on rear panel or front panel (swaps position with one 5-20R duplex). Front inlet can be straight or right-angled strain relief connector (with the cable passing through an access hole in the recessed mounting bracket).
- Standard main power four-pole circuit breaker with a power on indicator for each phase.
- Standard surge suppression.
- Standard remote switching / remote EPO interface.
- Standard EMI filter.
- Standard 16/20 A utility circuit with one 5-20R duplex (not subject to the EPO system).
- Three 16/20 A circuits:
  - having either one 5-20R duplex or 6-20R duplex, and
  - one twist-lock outlet.
  - Subject to the remote EPO system.
  - All three circuits have the same twist-lock type with a choice of L5-20R, L5-30R, L6-20R, L6-30R, or L21-30R connectors. The 20 A connectors are subject to the branch breakers, but the 30 A connectors are subject only to the main breaker.
- Certified to UL 62368-1.



All 10 models are 120/208 Vac, 24/30 A capacity. All models include one 5-20R utility duplex. Outlets include 5-20R or 6-20R duplexes with a choice of three additional twist-lock outlets. The inlet location may be on the front or rear panel, with the front-mount option allowing for either a straight or right-angled strain relief.

## Relevant Links

[Optima 532 web page](#)

[All Optima 5 Series web page](#)

[Commander EPO Panels web page](#)

[Optima 532 Operating Guide](#)



Mounting brackets are relocatable to allow for different mounting positions. The 2U model brackets also feature a passthrough opening to direct the inlet cable to the interior of the rack when the brackets are mounted for a recessed-chassis position. Brackets can be flipped to allow rear-facing positions as well.

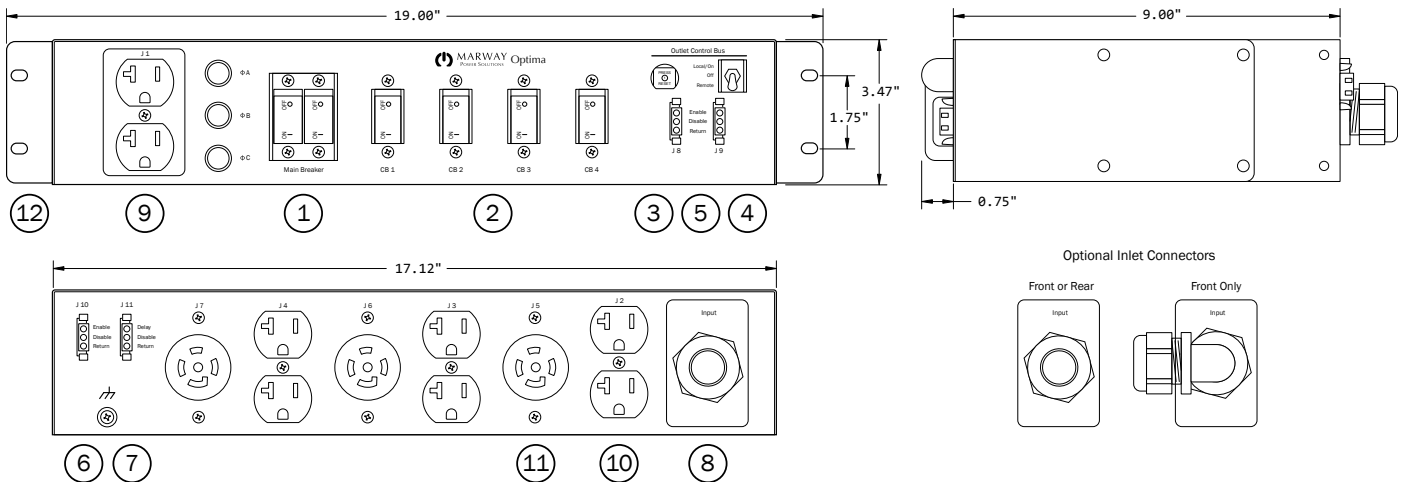

## 532 Series Map of Features

### Standard Features

- (1) Main 24/30 A breaker and phase-power indicators.
- (2) Branch 16/20 A circuit breakers for outlets. CB1 is for J1. CB2 is for J2 and J5. CB3 is for J3 and J6. CB4 is for J4 and J7.
- (3) Internal controls 1 A, push-type breaker.
- (4) Remote EPO mode switch. A three-position toggle provides manual control over the remote EPO mode. The Local/On position forces all outlets powered on, and only the remote EPO button will have affect (not the remote on/off). The Off position forces all outlets off, and the remote panel has no affect. The Remote position allows full control of the outlets by the remote panel.
- (5) Front panel remote EPO control bus interface. Two connectors enable the PDU to be daisy chained between a remote EPO panel (such as Marway's UCP) and another PDU, or between two PDUs.
- (6) Rear panel remote EPO interface. A third connector for when a rear connection is more convenient.
- (7) Rear panel remote EPO delay interface. When the Enable signal of a remote panel is triggered, the signal is propagated immediately to all downstream devices through the connectors identified by (5) and (6). This connector (7) introduces a delay of 2 seconds before forwarding the Enable signal. By daisy chaining PDUs with the delay connectors, a staggered start can be created between each downstream PDU.

- (12) Mounting brackets. May be mounted to yield a "flush," front-recessed, rear-facing, or rear-recessed position of the chassis relative to the rack's mounting flanges. The brackets include a cutout to allow an inlet cable to be directed into the interior of the rack when the brackets are mounted for a recessed-chassis position. The brackets may also be removed for table top operation, or adaptation of the end user's own brackets.

### Optional Configurations

- (8) Power inlet. All models include a strain-relieved 9-foot cable with an L21-30 plug. Some models include a straight connector as shown. Some models include a straight or right-angled connector on the front panel (not shown). See the description of the mounting brackets (12).
- (9) A 5-20R duplex at J1 is standard on all models. The location of the J1 duplex and the Inlet connector (8) are swapped on some models. Therefore, the inlet can be located on the rear panel or the front panel.
- (10) All models include 5-20R or 6-20R duplexes at J2, J3, and J4 on the rear panel.
- (11) All models include twist-lock connectors at J5, J6, and J7. All three will be of the same type with a choice from L5-20, L5-30, L6-20, L6-30, and L21-30.

## Specification Summary

### Inlet Voltage and Current

- All models 120/208 Vac, 50/60 Hz, three-phase wye
- All models 24 A continuous load / 30 A maximum

### Overload Protection

- All models include a four-pole main circuit breaker wired with all three phases and neutral passing through the breaker.
- All branch breakers are UL 489, 16 A continuous load / 20 A max.
- Based on NEC regulations, traditional load ratings are de-rated to 80% for continuous duty. For example, a traditional 30 A maximum rating is now interpreted and labeled as a 24 A continuous duty rating. Optima current ratings are shown with continuous/maximum rating values.

### Surge Suppression

- All models include a thermally protected varistor on each phase with a single-pulse energy rating of 120 joules
- All models have a peak surge current rating of 10,000 A for a single pulse 8x20µs wave.

### Environment

- Operating Temperature: 32 °F to 122 °F
- Maximum Altitude: 6,562 feet
- Relative Humidity: 5% to 85% non-condensing

### EMI Filter

- All models have < 1.0 mA leakage.

### Typical Insertion Loss (closed 50 Ohm system)

Frequency (MHz)	0.15	0.5	1	10	30
Common Mode (dB)	55	62	65	50	45
Differential Mode (dB)	36	55	60	60	50

### Remote EPO

- Panel connector: AMP #1-480304-0, 250 Vac, 4 A maximum.
- Mating cable connector: AMP #1-480305-0.
- Connectors J8, J9, J10 are wired in parallel. J11 has enable delay.
- All outlets other than J1 are managed by the Remote Control Bus.
- J1 outlets are always powered relative to the Main Breaker state.

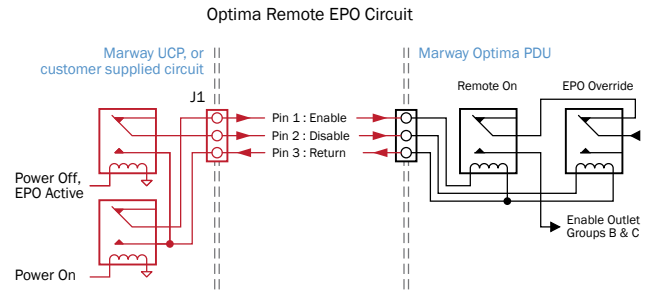



Optima 532 Series PDUs

MPD 532004-000 (N.O) / -001 (N.C.)

Amps Max<sup>1</sup>      3ph Wye Vac      Straight Inlet 9 ft  
**30**            **120/208**            **L21-30P**

NEMA            **5-20**      **L21-30**  
 Outlets            (8)            (3)

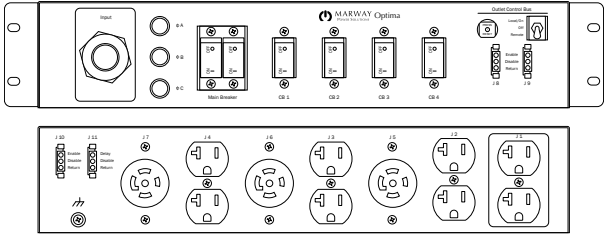

MPD 532009-000 (N.O) / -001 (N.C.)

Amps Max<sup>1</sup>      3ph Wye Vac      Straight Inlet 9 ft  
**30**            **120/208**            **L21-30P**

NEMA            **5-20**      **6-20**      **L21-30**  
 Outlets            (2)            (6)            (3)

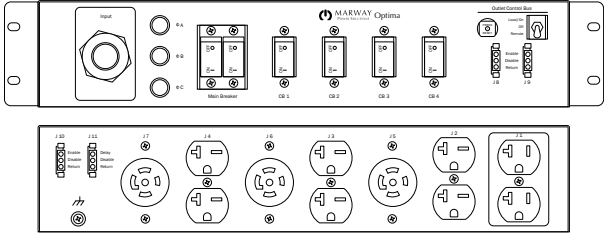

MPD 532014-000 (N.O) / -001 (N.C.)

Amps Max<sup>1</sup>      3ph Wye Vac      Angled Inlet 9 ft  
**30**            **120/208**            **L21-30P**

NEMA            **5-20**      **L21-30**  
 Outlets            (8)            (3)

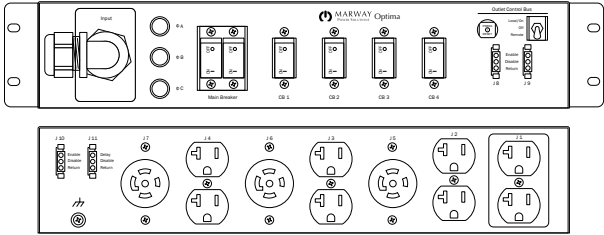

MPD 532020-000 (N.O) / -001 (N.C.)

Amps Max<sup>1</sup>      3ph Wye Vac      Rear Inlet 9 ft  
**30**            **120/208**            **L21-30P**

NEMA            **5-20**      **L5-20**  
 Outlets            (8)            (3)

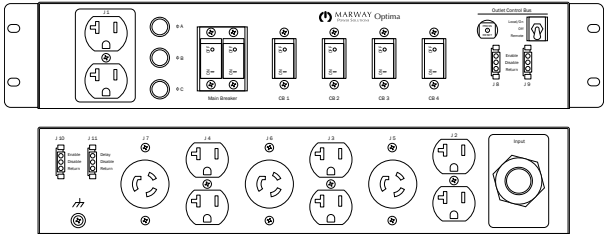

[1] Continuous load duty rating is 80% of Amps Max.  
 All Models – General chassis style shown. Details may vary. Specifications and availability subject to change without notice.

Optima 532 Series PDUs

MPD 532021-000 (N.O) / -001 (N.C.)

Amps Max<sup>1</sup>      3ph Wye Vac      Rear Inlet 9 ft  
**30**            **120/208**            **L21-30P**

NEMA  
Outlets      **5-20**      **L5-30**  
                   (8)            (3)

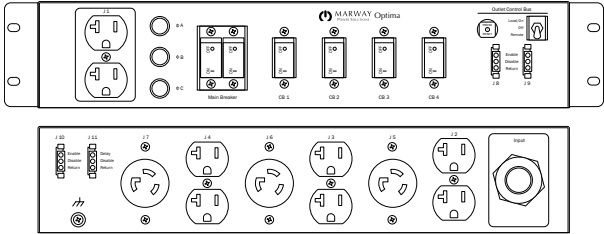

MPD 532022-000 (N.O) / -001 (N.C.)

Amps Max<sup>1</sup>      3ph Wye Vac      Rear Inlet 9 ft  
**30**            **120/208**            **L21-30P**

NEMA  
Outlets      **5-20**      **L6-20**  
                   (8)            (3)

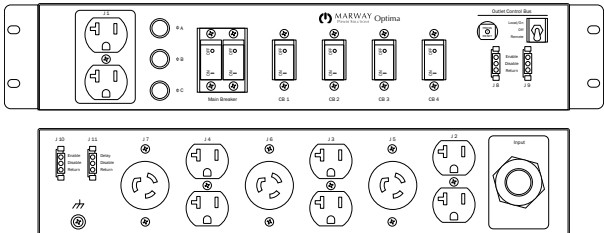

MPD 532024-000 (N.O) / -001 (N.C.)

Amps Max<sup>1</sup>      3ph Wye Vac      Rear Inlet 9 ft  
**30**            **120/208**            **L21-30P**

NEMA  
Outlets      **5-20**      **L21-30**  
                   (8)            (3)

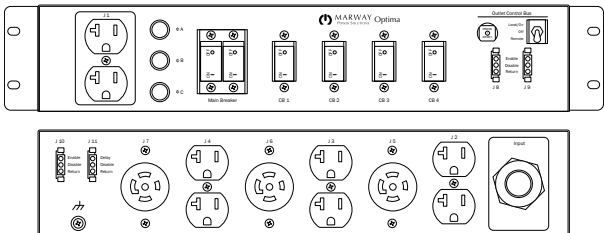

MPD 532025-000 (N.O) / -001 (N.C.)

Amps Max<sup>1</sup>      3ph Wye Vac      Angled Inlet 9 ft  
**30**            **120/208**            **L21-30P**

NEMA  
Outlets      **5-20**      **6-20**      **L5-20**  
                   (2)            (6)            (3)

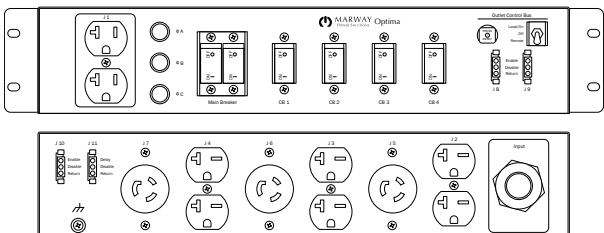

[1] Continuous load duty rating is 80% of Amps Max.  
 All Models – General chassis style shown. Details may vary. Specifications and availability subject to change without notice.

Optima 532 Series PDUs

MPD 532028-000 (N.O) / -001 (N.C.)

Amps Max<sup>1</sup>      3ph Wye Vac      Rear Inlet 9 ft  
**30**            **120/208**            **L21-30P**

NEMA            **5-20**    **6-20**    **L6-30**  
 Outlets            (2)        (6)        (3)

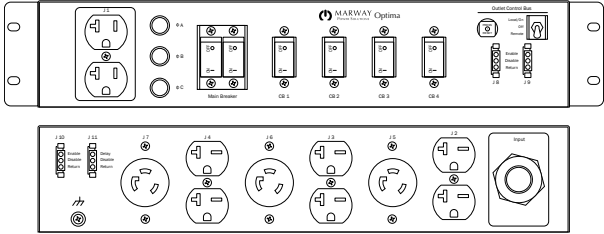

MPD 532029-000 (N.O) / -001 (N.C.)

Amps Max<sup>1</sup>      3ph Wye Vac      Rear Inlet 9 ft  
**30**            **120/208**            **L21-30P**

NEMA            **5-20**    **6-20**    **L21-30**  
 Outlets            (2)        (6)        (3)

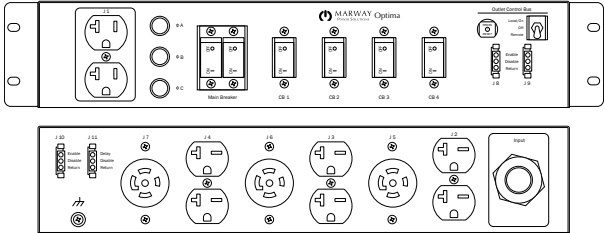

Remote Bus Cables

These cables are for the Remote Control Bus.

Part Number	PDU Connector	Cable Connector A	Cable Connector B	Remote Connector	Length
400075-120	AMP 1-480304-0	AMP 1-480305-0	AMP 1-480305-0	AMP 1-480304-0	10 feet
400062-120	AMP 1-480304-0	AMP 1-480305-0	Molex 03-09-3032	Molex 03-09-1081	10 feet

[1] Continuous load duty rating is 80% of Amps Max.  
 All Models – General chassis style shown. Details may vary. Specifications and availability subject to change without notice.



# Optima™ 533 Series

Three-Phase 3U Basic PDUs

## Maximum Connectivity and Flexibility

Eight individually breakered circuits, and 15 or 16 outlets provides the highest power management flexibility of the Optima 5 Series products. With standard surge suppressor, EMI filter, and remote EPO, this 3-phase, 30-amp unit provides a high density solution for industrial environments.

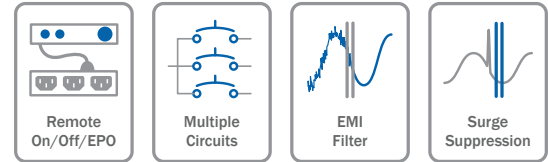

## Shared Feature Highlights

- 3U chassis with removable/relocatable mounting brackets.
- 120/208 Vac 3 $\phi$  wye, 50/60 Hz, 24 A continuous duty (30 A maximum), L21-30P inlet.
- Inlet available on rear panel or front panel. The front panel inlet connector is a recessed male (cable not included), while the rear panel inlet connector is a strain-relieved cable. Cables are 9 feet long with an L21-30 plug.
- Standard main power four-pole circuit breaker with a power on indicator for each phase.
- Standard surge suppression.
- Standard remote switching / remote EPO interface.
- Standard EMI filter.
- Standard 16/20 A utility circuit with one 5-20R duplex (not subject to the EPO system).
- One set of models includes eight 16/20 A circuits, each having one 5-20R duplex. These eight-duplex models do not include additional twist-lock connectors.
- All other models include six 16/20 A circuits, each with one 5-20R duplex. These six-duplex models also have three twist-lock connectors as described below.
- The six-duplex models include two 16/20 A circuits each with a twist-lock outlet. Both have the same twist-lock type with a choice of L5-20R, L5-30R, L6-20R, or L6-30R.
- The six-duplex models also include one 24/30 A pass-through off the main breaker with one L21-30R connector.
- Certified to UL 62368-1.



## Relevant Links

[Optima 533 web page](#)

[All Optima 5 Series web page](#)

[Commander EPO Panels web page](#)

[Optima 533 Operating Guide](#)

There are seven configurations of 533 models providing options for outlet twist-lock connector types, and location of the inlet on the front or rear panel. Shown are two configurations of back panels where one set of models includes all 5-20R duplexes, and all other models include six duplexes and three twist lock connectors.

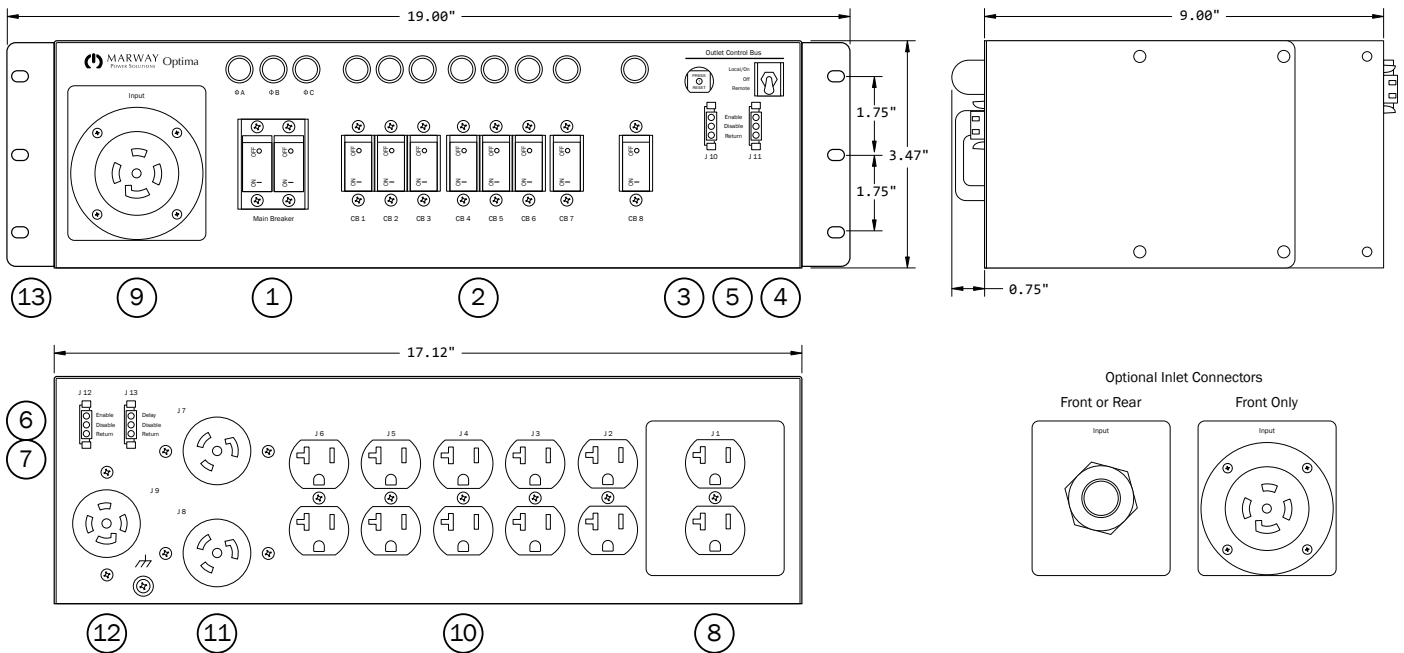

## 533 Series Map of Features

### Standard Features

- (1) Main 24/30 A breaker and phase-power indicators.
- (2) Branch 16/20 A circuit breakers for outlets. CB1 is for J1. CB2 is for J2, et cetera. There is no breaker for J9 on the models where J9 is included.
- (3) Internal controls 1 A, push-type breaker.
- (4) Remote EPO mode switch. A three-position toggle provides manual control over the remote EPO mode. The Local/On position forces all outlets powered on, and only the remote EPO button will have affect (not the remote on/off). The Off position forces all outlets off, and the remote panel has no affect. The Remote position allows full control of the outlets by the remote panel.
- (5) Front panel remote EPO control bus interface. Two connectors enable the PDU to be daisy chained between a remote EPO panel (such as Marway’s UCP) and another PDU, or between two PDUs.
- (6) Rear panel remote EPO interface. A third connector for when a rear connection is more convenient.
- (7) Rear panel remote EPO delay interface. When the Enable signal of a remote panel is triggered, the signal is propagated immediately to all downstream devices through the connectors identified by (5) and (6). This connector (7) introduces a delay of 2 seconds before forwarding the Enable signal. By daisy chaining

PDUs with the delay connectors, a staggered start can be created between each downstream PDU.

- (13) Mounting brackets. May be mounted to yield a “flush,” front-recessed, rear-facing, or rear-recessed position of the chassis relative to the rack’s mounting flanges. The brackets include a cutout to allow an inlet cable to be directed into the interior of the rack when the brackets are mounted for a recessed-chassis position. The brackets may also be removed for table top operation, or adaptation of the end user’s own brackets.

### Optional Configurations

- (8) A 5-20R duplex at J1 is standard on all models. The location of the J1 duplex and the Inlet connector (9) are swapped on some models. Therefore, the inlet can be located on the rear panel or the front panel.
- (9) Power inlet. Some models include a recessed male connector (cable not included). Some models include a strain-relieved 9-foot cable with an L21-30 plug.
- (10) All models include at least six 5-20R duplexes.
- (11) On some models, J7 and J8 are twist lock connectors (with a choice of L5-20, L5-30, L6-20, L6-30 where both are the same). On other models, J7 and J8 are 5-20R duplexes.
- (12) Models which include twist locks for J7 and J8 will also include J9 which is always an L21-30 providing pass-through power from the main breaker.

## Specification Summary

### Inlet Voltage and Current

- All models 120/208 Vac, 50/60 Hz, three-phase wye
- All models 24 A continuous load / 30 A maximum

### Overload Protection (standard)

- All models include a four-pole main circuit breaker wired with all three phases and neutral passing through the breaker.
- All branch breakers are UL 489, 16 A continuous load / 20 A max.
- Based on NEC regulations, traditional load ratings are de-rated to 80% for continuous duty. For example, a traditional 30 A maximum rating is now interpreted and labeled as a 24 A continuous duty rating. Optima current ratings are shown with continuous/maximum rating values.

### Surge Suppression

- All models include a thermally protected varistor on each phase with a single-pulse energy rating of 120 joules
- All models have a peak surge current rating of 10,000 A for a single pulse 8x20µs wave.

### Environment

- Operating Temperature: 32 °F to 122 °F
- Maximum Altitude: 6,562 feet
- Relative Humidity: 5% to 85% non-condensing

### EMI Filter

- All models have < 1.0 mA leakage.

### Typical Insertion Loss (closed 50 Ohm system)

Frequency (MHz)	0.15	0.5	1	10	30
Common Mode (dB)	55	62	65	50	45
Differential Mode (dB)	36	55	60	60	50

### Remote EPO

- Panel connector: AMP #1-480304-0, 250 Vac, 4 A maximum.
- Mating cable connector: AMP #1-480305-0.
- Connectors J8, J9, J10 are wired in parallel. J11 has enable delay.
- All outlets other than J1 are managed by the Remote Control Bus.
- J1 outlets (and J9 if present) are always powered relative to the Main Breaker state.

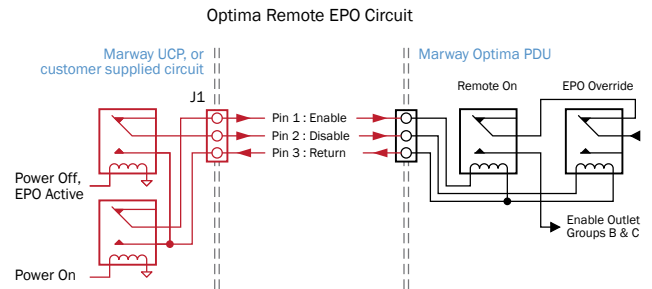

Optima 533 Series PDUs

**MPD 533005-000 (N.O) / -001 (N.C.)**

Amps Max<sup>1</sup>      3ph Wye Vac      Recessed Male Inlet  
**30**            **120/208**            **L21-30P**

NEMA  
Outlets      **5-20**  
                  **(16)**

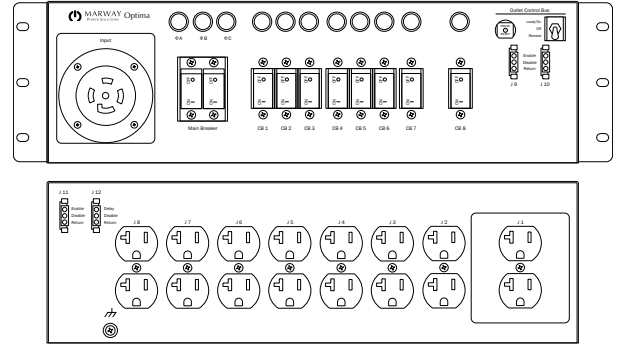

**MPD 533006-000 (N.O) / -001 (N.C.)**

Amps Max<sup>1</sup>      3ph Wye Vac      Recessed Male Inlet  
**30**            **120/208**            **L21-30P**

NEMA  
Outlets      **5-20**      **L5-20**      **L21-30**  
                  **(12)**            **(2)**            **(1)**

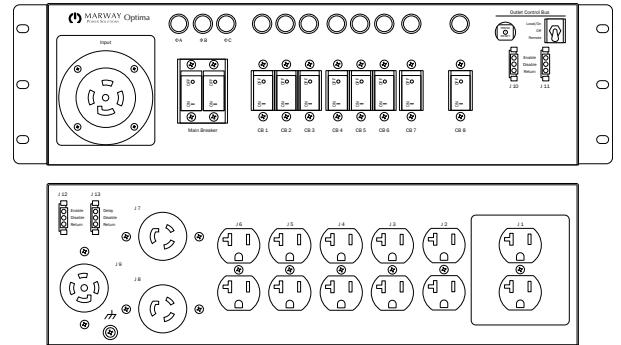

**MPD 533007-000 (N.O) / -001 (N.C.)**

Amps Max<sup>1</sup>      3ph Wye Vac      Recessed Male Inlet  
**30**            **120/208**            **L21-30P**

NEMA  
Outlets      **5-20**      **L5-30**      **L21-30**  
                  **(12)**            **(2)**            **(1)**

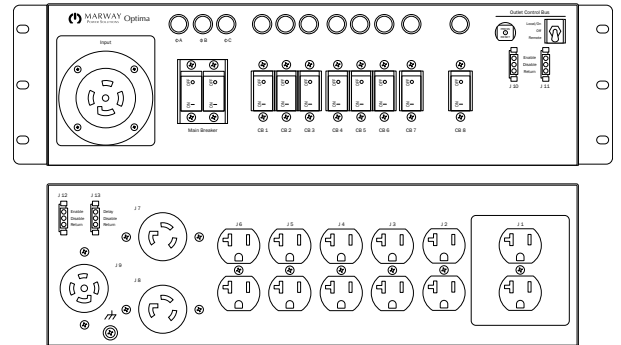

**MPD 533008-000 (N.O) / -001 (N.C.)**

Amps Max<sup>1</sup>      3ph Wye Vac      Recessed Male Inlet  
**30**            **120/208**            **L21-30P**

NEMA  
Outlets      **5-20**      **L6-20**      **L21-30**  
                  **(12)**            **(2)**            **(1)**

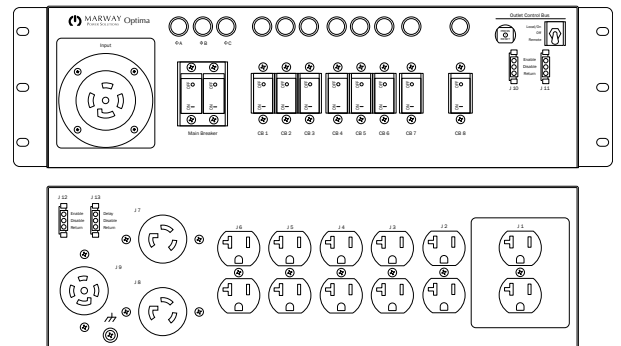

[1] Continuous load duty rating is 80% of Amps Max.  
 All Models – General chassis style shown. Details may vary. Specifications and availability subject to change without notice.

Optima 533 Series PDUs

**MPD 533009-000 (N.O) / -001 (N.C.)**

Amps Max<sup>1</sup>      3ph Wye Vac      Recessed Male Inlet  
**30**            **120/208**            **L21-30P**

NEMA Outlets      **5-20**      **L6-30**      **L21-30**  
                             (12)            (2)            (1)

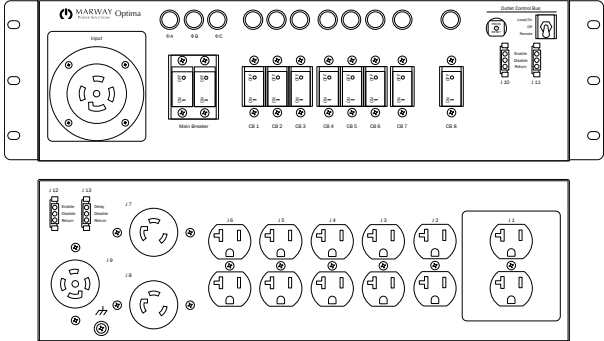

**MPD 533010-000 (N.O) / -001 (N.C.)**

Amps Max<sup>1</sup>      3ph Wye Vac      Rear Inlet Cable 9 ft  
**30**            **120/208**            **L21-30P**

NEMA Outlets      **5-20**  
                             (16)

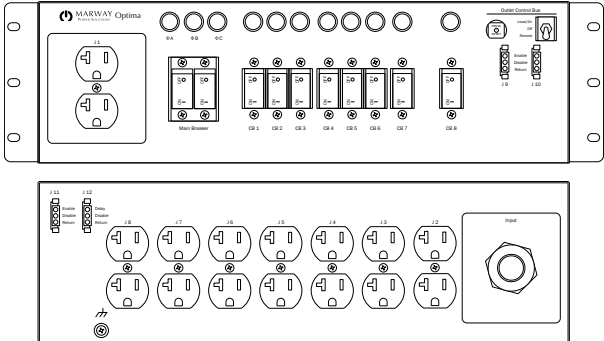

**MPD 533013-000 (N.O) / -001 (N.C.)**

Amps Max<sup>1</sup>      3ph Wye Vac      Rear Inlet Cable 9 ft  
**30**            **120/208**            **L21-30P**

NEMA Outlets      **5-20**      **L6-20**      **L21-30**  
                             (12)            (2)            (1)

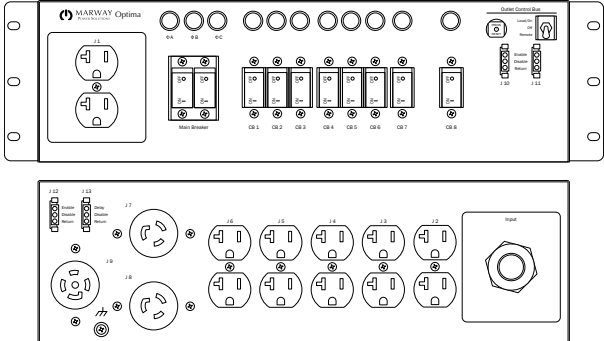

Remote Bus Cables

These cables are for the Remote Control Bus.

Part Number	PDU Connector	Cable Connector A	Cable Connector B	Remote Connector	Length
400075-120	AMP 1-480304-0	AMP 1-480305-0	AMP 1-480305-0	AMP 1-480304-0	10 feet
400062-120	AMP 1-480304-0	AMP 1-480305-0	Molex 03-09-3032	Molex 03-09-1081	10 feet

[1] Continuous load duty rating is 80% of Amps Max.  
 All Models – General chassis style shown. Details may vary. Specifications and availability subject to change without notice.





# Optima™ 529/539 Series

Single-Phase and Three-Phase 0U Basic PDUs

## Space Saving Vertical Installation

A vertical PDU frees up rack space for more application equipment, though the narrow size means leaving out some features the other Optima models have. With up to 30 amps of 3-phase power and up to 42 outlets, the 529/539 Series offers high power densities in a space-saving and cost-effective design well-suited to many applications. A variety of power options, inlet connectors, and outlet connectors results in 13 models to choose from.

## Feature Highlights

- 0U chassis in full-rack (66") and half-rack (40") sizes.
- End, side, and tool-less mounting options.
- Multiple inlet power options including:
  - 120 Vac single phase, 50/60 Hz, 12/15 A
  - 120 Vac single phase, 50/60 Hz, 16/20 A
  - 120 Vac single phase, 50/60 Hz, 24/30 A
  - 110-240 Vac single phase, 50/60 Hz, 16/20 A
  - 200-240 Vac single phase, 50/60 Hz, 24/30 A
  - 120/208 Vac three phase, 50/60 Hz, 24/30 A
- Standard UL 489 circuit breakers with power on indicator.
- A variety of inlet connector types including:
  - 5-15P, 5-20P
  - L5-20P, L5-30P
  - L6-30P
  - L21-30P
  - C20 recessed male
- A variety of outlet connector types including:
  - 5-15R, 5-20R,
  - C13, and C19.
- Certified to UL 62368-1.

## Relevant Links

[Optima 529](#) and [Optima 539](#) web pages

[All Optima 5 Series web page](#)

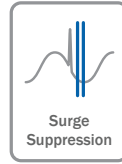
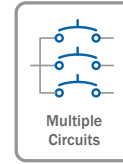

# Optima 529/539 Series PDUs

## Specification Summary

### Inlet Voltage Options

- 120 Vac, 50/60 Hz, single phase
- 110-240 Vac, 50/60 Hz, single phase
- 120/208 Vac, 50/60 Hz, three-phase wye
- All voltages are listed as nominal input sources.

### Current Capacity Options

- 12 A continuous load / 15 A maximum
- 16 A continuous load / 20 A maximum
- 24 A continuous load / 30 A maximum
- Based on NEC regulations, traditional load ratings are de-rated to 80% for continuous duty. For example, a traditional 30 A maximum rating is now interpreted and labeled as a 24 A continuous duty rating. Optima current ratings are shown with continuous/maximum rating values.

### Overload Protection (standard)

- All models include UL 489 two-pole circuit breakers.
- All single-phase models are wired with both line and neutral passing through the two-pole circuit breaker.
- All three-phase wye models are wired with both line and neutral passing through the two-pole circuit breaker.
- All multi-breaker models are wired with one outlet group per breaker.

### Environment

- Operating Temperature: 32 °F to 122 °F
- Maximum Altitude: 6,562 feet
- Relative Humidity: 5% to 85% non-condensing

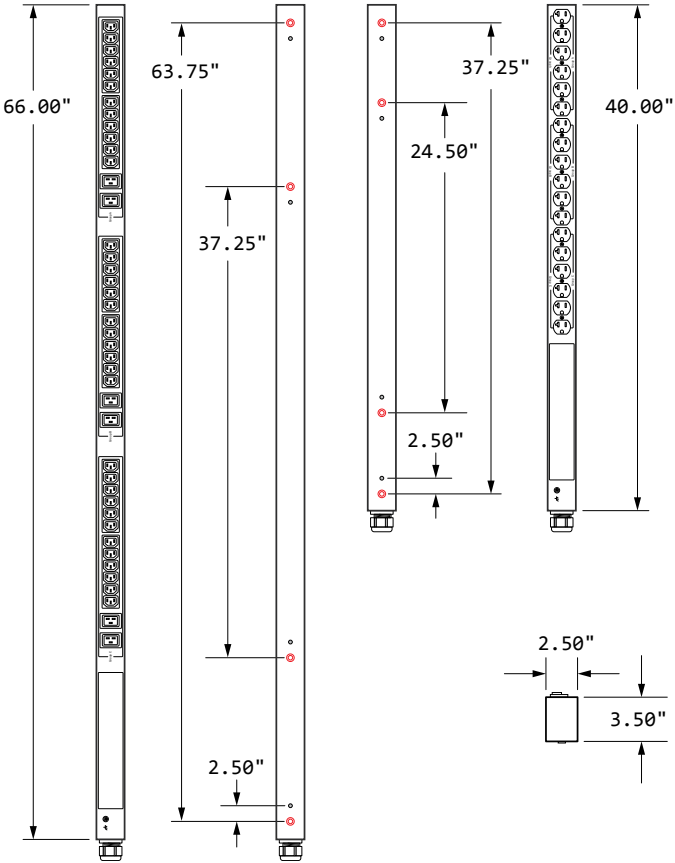

Optima 529/539 Series PDUs

**MPD 529001-000**

Amps Max<sup>1</sup> **20**      1ph Vac **110-240**      Inlet Connector **C20**      Circuits **1 @ 20A**      IEC Outlets **C13 (36)**      **C19 (6)**



**MPD 529004-000**

Amps Max<sup>1</sup> **30**      1ph Vac **200-240**      Inlet Cable 15 ft **L6-30P**      Circuits **3 @ 20A**      IEC Outlets **C13 (36)**      **C19 (6)**

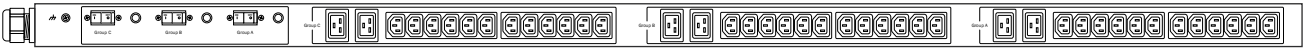

**MPD 539002-000**

Amps Max<sup>1</sup> **30**      3ph Wye Vac **120/208**      Inlet Cable 15 ft **L21-30P**      Circuits **3 @ 20A**      IEC Outlets **C13 (36)**      **C19 (6)**



**MPD 529009-000**

Amps Max<sup>1</sup> **20**      1ph Vac **110-240**      Inlet Connector **C20**      Circuits **1 @ 20A**      IEC Outlets **C13 (18)**      **C19 (3)**



**MPD 529012-000**

Amps Max<sup>1</sup> **30**      1ph Vac **200-240**      Inlet Cable 15 ft **L6-30P**      Circuits **3 @ 20A**      IEC Outlets **C13 (18)**      **C19 (3)**



**MPD 539006-000**

Amps Max<sup>1</sup> **30**      3ph Wye Vac **120/208**      Inlet Cable 15 ft **L21-30P**      Circuits **3 @ 20A**      IEC Outlets **C13 (18)**      **C19 (3)**



[1] Continuous load duty rating is 80% of Amps Max.  
All Models – General chassis style shown. Details may vary. Specifications and availability subject to change without notice.

Optima 529/539 Series PDUs

**MPD 529006-000**

Amps Max<sup>1</sup>      1ph Vac      Inlet Cable 15 ft      Circuits      NEMA Outlets      **5-20**  
**20**      **100-120**      **5-20P**      **1 @ 20A**      (36)

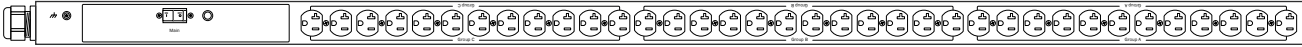

**MPD 529008-000**

Amps Max<sup>1</sup>      1ph Vac      Inlet Cable 15 ft      Circuits      NEMA Outlets      **5-20**  
**30**      **100-120**      **L5-30P**      **3 @ 20A**      (36)

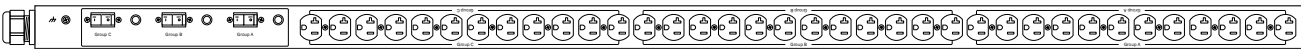

**MPD 539004-000**

Amps Max<sup>1</sup>      3ph Wye Vac      Inlet Cable 15 ft      Circuits      NEMA Outlets      **5-20**  
**30**      **120/208**      **L21-30P**      **3 @ 20A**      (36)

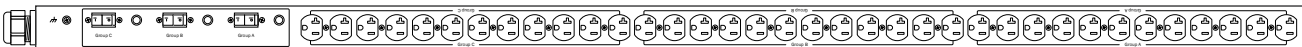

**MPD 529014-000**

Amps Max<sup>1</sup>      1ph Vac      Inlet Cable 15 ft      Circuits      NEMA Outlets      **5-20**  
**20**      **100-120**      **5-20P**      **1 @ 20A**      (18)

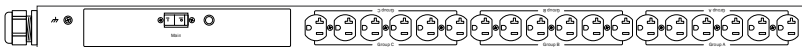

**MPD 529015-000**

Amps Max<sup>1</sup>      1ph Vac      Inlet Cable 15 ft      Circuits      NEMA Outlets      **5-20**  
**20**      **100-120**      **L5-20P**      **1 @ 20A**      (18)

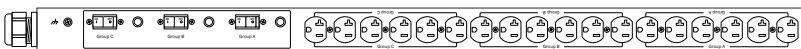

**MPD 539008-000**

Amps Max<sup>1</sup>      3ph Wye Vac      Inlet Cable 15 ft      Circuits      NEMA Outlets      **5-20**  
**30**      **120/208**      **L21-30P**      **3 @ 20A**      (18)



[1] Continuous load duty rating is 80% of Amps Max.  
 All Models – General chassis style shown. Details may vary. Specifications and availability subject to change without notice.

# Optima 529/539 Series PDUs

## MPD 529005-000

Amps Max<sup>1</sup>      1ph Vac      Inlet Cable 15 ft      Circuits      NEMA Outlets

**15**      **100-120**      **5-15P**      **1 @ 15A**      **5-15**  
**(36)**



[1] Continuous load duty rating is 80% of Amps Max.  
All Models – General chassis style shown. Details may vary. Specifications and availability subject to change without notice.



# Optima™ 320 Series

## Single-Phase 1U Basic PDUs

### Power Essentials in a Light Industrial Package

The Optima 320 Series is Marway's most readily-available and budget-conscious line of power distribution units. These units focus on the most common features we're asked for in a simple, general purpose PDU while still having it provide better protection for downstream equipment than commodity systems.

#### Feature Highlights

- EMI filter for common mode and differential mode noise reduction.
- Surge protector for voltage spike suppression.
- UL 489 hydraulic magnetic circuit breaker(s) with power on indicator(s).
- High outlet count in two configurations:
  - 14 outlets (2 on front, 12 on back) with a single breaker.
  - 16 outlets (8 on front, 8 on back) with dual breakers.
- 5-15R, 5-20R, or C13 outlets, and one model with a mix of (4) C19 and (12) C13 outlets.
- 120 Vac, or 100–240 Vac 1 $\phi$  power sources.
- 12 A, 16 A, or 24 A continuous-duty capacity (15 A, 20 A, or 30 A maximum capacity).
- The 14-outlet models are available in versions with on-board digital metering of current and voltage.
- The 16-outlet, 8-front/8-back models provide flexibility in environments where the PDU may be repurposed in front vs. rear access use.
- All models are UL 62368-1 certified and CE marked.

#### Relevant Links

[Optima 320 web page](#)

[All Optima 3 Series web page](#)

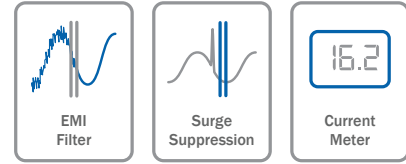

This 2-front/12-back configuration is available with 5-15R, 5-20R, or C13 outlets.



For greater versatility, this 8-front/8-back configuration has dual circuit breakers and is available with 5-15R, 5-20R, or C13 outlets.



Specialized for information server environments, this model provides a mix of C19 and C13 connections on both the front and back.



The 2-front/12-back configurations also come in versions with digital metering of current and voltage.



The MPD 320001-000 is the simplest unit for the most basic applications still needing a 1U steel chassis, but no circuit breaker, no surge protector, and no EMI filter.

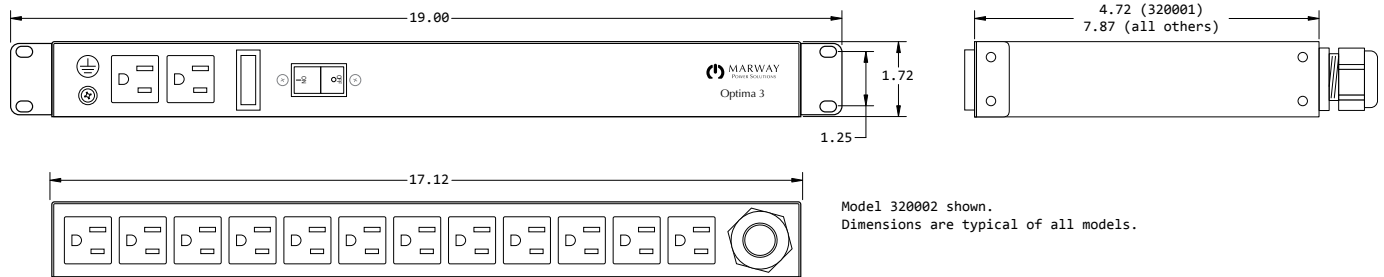

## Inlet Voltage Options

- 120 Vac, 50/60 Hz, single phase
- 100–240 Vac, 50/60 Hz, single phase
- All voltages are listed as nominal input sources.

## Current Capacity Options

- 12 A continuous load / 15 A maximum (5-15P inlet)
- 16 A maximum (C20 inlet)
- 16 A continuous load / 20 A maximum (5-20P inlet)
- 24 A continuous load / 30 A maximum (L5-30P, L6-30P inlets)
- Based on NEC regulations, traditional load ratings are de-rated to 80% for continuous duty. For example, a traditional 30 A maximum rating is now interpreted and labeled as a 24 A continuous duty rating. Optima current ratings are shown with continuous/maximum rating values.

## Overload Protection (standard)

- All models (except 320001) include UL 489 circuit breakers.
- All 120 Vac models (except 320001) use single-pole breakers.
- All 100-240 Vac models use double-pole breakers.
- All multi-breaker models are wired with one outlet group per breaker.

## Regulatory

- All models certified to UL 62368-1.
- All models CE marked.

## Environment

- Operating Temperature: 32 °F to 122 °F
- Maximum Altitude: 6,562 feet
- Relative Humidity: 5% to 85% non-condensing

## Digital Meter (some units)

- Volts RMS is measured  $\pm 2\%$ , updated every 15 s.
- Amps RMS is measured  $\pm 2\%$ , updated every 15 s.

## Surge Suppression (standard)

- All models (except 320001) include a varistor.
- 120 Vac models (except 320001) have a single-pulse energy rating of 200 joules.
- 240 Vac models have a single-pulse energy rating of 350 joules.
- All models (except 320001) have a peak surge current rating of 10,000 A for a single pulse  $8 \times 20 \mu\text{s}$  wave.

## EMI Filter (standard)

- All models (except 320001) include an EMI filter.
- All models have  $\leq 0.6$  mA leakage.

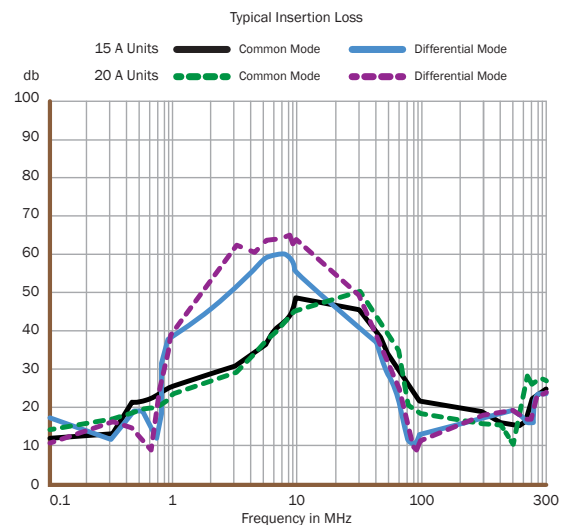

Optima 320 Series PDUs

MPD 320001-000

<b>Voltage</b>  120 Vac	<b>Current</b>  12/15 Amps	<b>Inlet</b>  5-15P/9ft	<b>Outlets</b>  5-15R
-------------------------------	----------------------------------	-------------------------------	-----------------------------



- (14) 5-15R outlets
- NO circuit breaker, surge suppressor, or EMI filter

MPD 320002-000

<b>Voltage</b>  120 Vac	<b>Current</b>  12/15 Amps	<b>Inlet</b>  5-15P/9ft	<b>Outlets</b>  5-15R
-------------------------------	----------------------------------	-------------------------------	-----------------------------

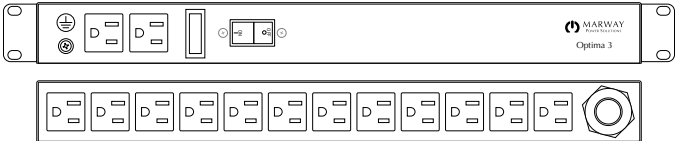

- (14) 5-15R outlets
- (1) 15 A circuit breaker
- Surge suppressor and EMI filter

MPD 320003-000

<b>Voltage</b>  120 Vac	<b>Current</b>  16/20 Amps	<b>Inlet</b>  5-20P/9ft	<b>Outlets</b>  5-20R
-------------------------------	----------------------------------	-------------------------------	-----------------------------

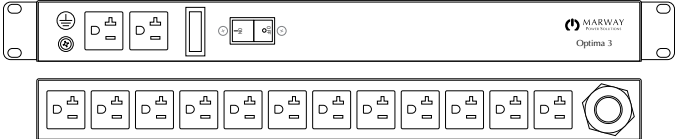

- (14) 5-20R outlets
- (1) 20 A circuit breaker
- Surge suppressor and EMI filter

MPD 320004-000

<b>Voltage</b>  100-240 Vac	<b>Current</b>  16 Amps	<b>Inlet</b>  C20/Panel	<b>Outlets</b>  C13
-----------------------------------	-------------------------------	-------------------------------	---------------------------

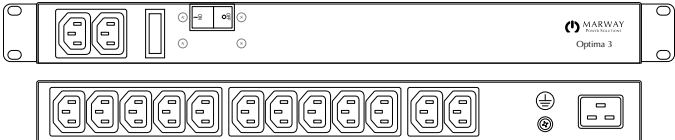

- (14) C13 outlets
- (1) 20 A circuit breaker
- Surge suppressor and EMI filter

Specifications and availability subject to change without notice. General enclosure styles are depicted, though actual model-specific appearance may vary from all model illustrations.



Optima 320 Series PDUs

MPD 320005-000

<b>Voltage</b>  120 Vac	<b>Current</b>  12/15 Amps	<b>Inlet</b>  5-15P/9ft	<b>Outlets</b>  5-15R
-------------------------------	----------------------------------	-------------------------------	-----------------------------

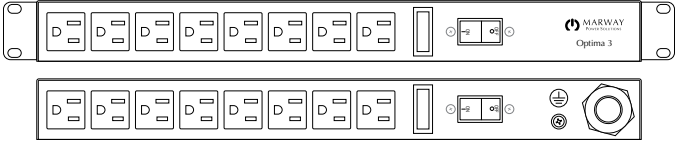

- (16) 5-15R outlets
  - (2) 15 A circuit breakers
  - Surge suppressor and EMI filter
- Note: the dual circuits are for flexibility, not added capacity. Consider the 320006 model for added current capacity.

MPD 320006-000

<b>Voltage</b>  120 Vac	<b>Current</b>  24/30 Amps	<b>Inlet</b>  L5-30P/9ft	<b>Outlets</b>  5-20R
-------------------------------	----------------------------------	--------------------------------	-----------------------------

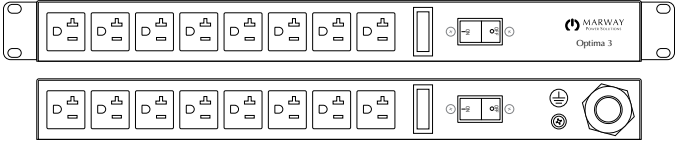

- (16) 5-20R outlets
- (2) 20 A circuit breakers
- Surge suppressor and EMI filter

MPD 320007-000

<b>Voltage</b>  100-240 Vac	<b>Current</b>  16 Amps	<b>Inlet</b>  C20/Panel	<b>Outlets</b>  C13
-----------------------------------	-------------------------------	-------------------------------	---------------------------

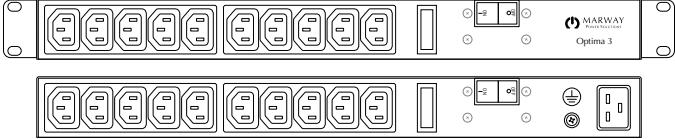

- (16) C13 outlets
  - (2) 20 A circuit breakers
  - Surge suppressor and EMI filter
- Note: the dual circuits are for flexibility, not added capacity. Consider the 320008 model for added current capacity.

MPD 320008-000

<b>Voltage</b>  100-240 Vac	<b>Current</b>  24/30 Amps	<b>Inlet</b>  L6-30P/9ft	<b>Outlets</b>  C13 / C19
-----------------------------------	----------------------------------	--------------------------------	---------------------------------

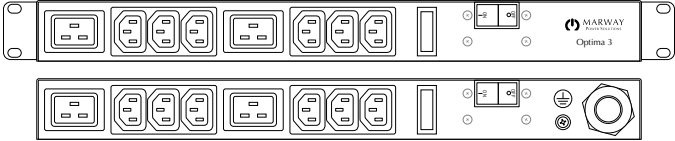

- (12) C13 outlets, (4) C19 outlets
- (2) 20 A circuit breakers
- Surge suppressor and EMI filter

Specifications and availability subject to change without notice. General enclosure styles are depicted, though actual model-specific appearance may vary from all model illustrations.

# Optima 320 Series PDUs

## MPD 320009-000

<b>Voltage</b>  120 Vac	<b>Current</b>  12/15 Amps	<b>Inlet</b>  5-15P/9ft	<b>Outlets</b>  5-15R
-------------------------------	----------------------------------	-------------------------------	-----------------------------

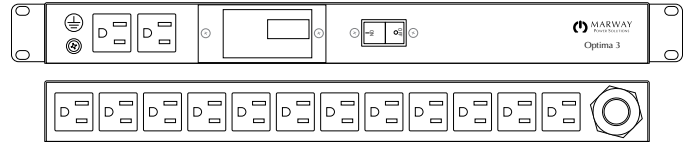

- (14) 5-15R outlets
- (1) 15 A circuit breaker
- Surge suppressor and EMI filter
- Digital display

## MPD 320010-000

<b>Voltage</b>  120 Vac	<b>Current</b>  16/20 Amps	<b>Inlet</b>  5-20P/9ft	<b>Outlets</b>  5-20R
-------------------------------	----------------------------------	-------------------------------	-----------------------------

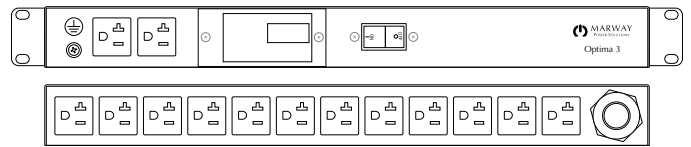

- (14) 5-20R outlets
- (1) 20 A circuit breaker
- Surge suppressor and EMI filter
- Digital display

## MPD 320011-000

<b>Voltage</b>  100-240 Vac	<b>Current</b>  16 Amps	<b>Inlet</b>  C20/Panel	<b>Outlets</b>  C13
-----------------------------------	-------------------------------	-------------------------------	---------------------------

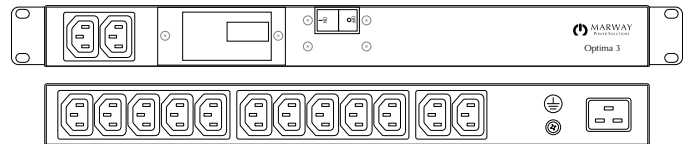

- (14) C13 outlets
- (1) 20 A circuit breaker
- Surge suppressor and EMI filter
- Digital display

## Power Cables

These power cables are for models which have the recessed, male C20 connector.

Part Number	PDU	Facility	Length
311114-001	C19	C20	8 feet
311114-002	C19	L6-20P	8 feet
311114-003	C19	6-20P	8 feet
311114-004	C19	L5-20P	8 feet
311114-005	C19	5-20P	8 feet
311114-000	C19	Wire Leads	8 feet

## Cable Bracket

Steel bracket, powder coated black. Fits onto the back of any Optima 320, 520, or 820. Adds approximately 3.5" to the back of the PDU.

Part Number 113286-000

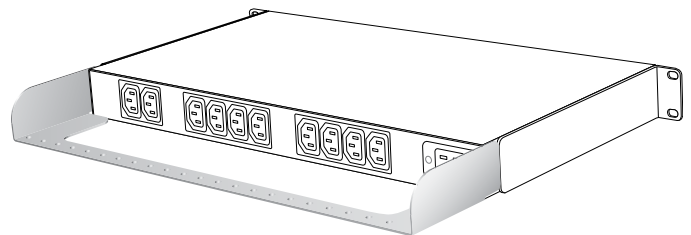



# Optima™ 329 Series

## Single-Phase 0U Basic PDUs

### Space Saving Vertical Installation

As part of the budget-conscious 3 Series, the 329 models are vertical PDU which free up rack space for more application equipment. Though the narrow size means leaving out the EMI filter included with other Optima models, these units provide added flexibility to a rack which does not need EMI protection.

#### Feature Highlights

- All models include on-board digital metering and display of current and voltage for each circuit.
- Surge protector for voltage spike suppression.
- UL 489 hydraulic magnetic circuit breaker(s) with power on indicator(s).
- Black powder coated 18 ga steel chassis with tool-less mounting buttons.
- All models are UL 62368-1 certified and CE marked.

### Focused, but Flexible

Focusing on the essentials of general purpose applications, the Optima 329 offers lower costs and quicker availability than Marway's build-to-order lines. Still, the 4 models provide the flexibility to match many applications.

- Model 329001
  - Outlets: (15) 5-20R with a single 20 A breaker.
  - Inlet: 5-20P with 9' cord, 16 A continuous duty.
- Model 329002
  - Outlets: (12) C13 and (3) C19 with a single 20 A breaker.
  - Inlet: C20, 16 A continuous duty.
- Model 329003
  - Outlets: (30) 5-20R with a two 20 A breakers.
  - Inlet: L5-30P with 9' cord, 24 A continuous duty.
- Model 329004
  - Outlets: (24) C13 and (6) C19 with a two 20 A breakers.
  - Inlet: L6-30P with 9' cord, 24 A continuous duty.

#### Relevant Links

[Optima 329 web page](#)

[All Optima 3 Series web page](#)

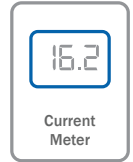
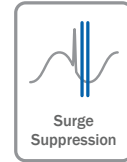

The digital meter auto rotates between displaying current and voltage.



## Specification Summary

### Inlet Voltage Options

- 120 Vac, 50/60 Hz, single phase
- 100–240 Vac, 50/60 Hz, single phase
- All voltages are listed as nominal input sources.

### Current Capacity Options

- 16 A maximum (C20 inlet)
- 16 A continuous load / 20 A maximum (5-20P inlet)
- 24 A continuous load / 30 A maximum (5-30P, L6-30P inlets)
- Based on NEC regulations, traditional load ratings are de-rated to 80% for continuous duty. For example, a traditional 30 A maximum rating is now interpreted and labeled as a 24 A continuous duty rating. Optima current ratings are shown with continuous/maximum rating values except where IEC ratings dictate maximum values only.

### Overload Protection (standard)

- All models include UL 489 circuit breakers.
- All 120 Vac models use single-pole breakers.
- All 100-240 Vac models use double-pole breakers.
- All multi-breaker models are wired with one outlet group per breaker.

### Surge Suppression (standard)

- All models include a varistor.
- 120 Vac models have a single-pulse energy rating of 200 joules.
- 240 Vac models have a single-pulse energy rating of 350 joules.
- All models have a peak surge current rating of 10,000 A for a single pulse 8x20µs wave.

### Digital Meter (some units)

- Volts RMS is measured  $\pm 2\%$ , updated every 15 s.
- Amps RMS is measured  $\pm 2\%$ , updated every 15 s.

### Regulatory

- All models certified to UL 62368-1.
- All models CE marked.

### Environment

- Operating Temperature: 32 °F to 113 °F
- Maximum Altitude: 6,562 feet
- Relative Humidity: 5% to 85% non-condensing

### Dimensions

- Typical for all outlet types
- Download detailed drawings from web site

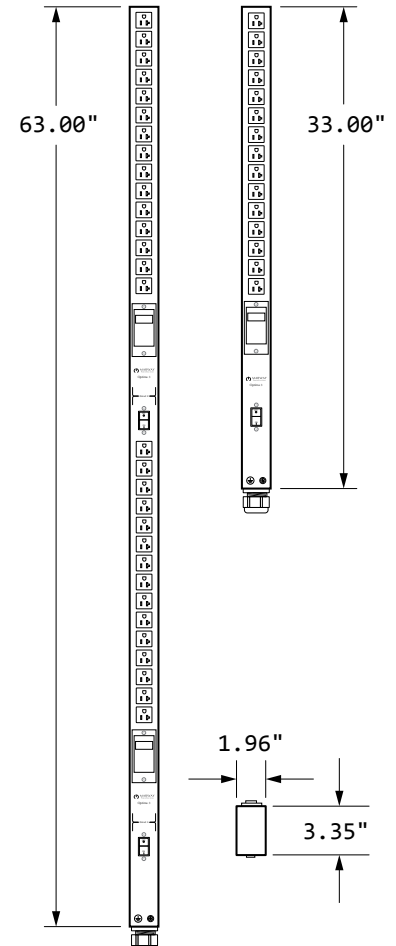

# Optima 329 Series PDUs

## MPD 329001-000

<b>Voltage</b>  120 Vac	<b>Current</b>  16/20 Amps	<b>Inlet</b>  5-20P/9ft	<b>Outlets</b>  5-20R	<b>Enclosure</b>  Short Rack
-------------------------------	----------------------------------	-------------------------------	-----------------------------	------------------------------------

- (15) 5-20R outlets
- (1) 20 A circuit breaker
- Surge suppressor
- Digital display

## MPD 329002-000

<b>Voltage</b>  100-240 Vac	<b>Current</b>  16 Amps	<b>Inlet</b>  C20/Panel	<b>Outlets</b>  C13 / C19	<b>Enclosure</b>  Short Rack
-----------------------------------	-------------------------------	-------------------------------	---------------------------------	------------------------------------

- (12) C13 outlets
- (3) C19 outlets
- (1) 20 A circuit breaker
- Surge suppressor
- Digital display

## MPD 329003-000

<b>Voltage</b>  120 Vac	<b>Current</b>  24/30 Amps	<b>Inlet</b>  L5-30P/9ft	<b>Outlets</b>  5-20R	<b>Enclosure</b>  Full Rack
-------------------------------	----------------------------------	--------------------------------	-----------------------------	-----------------------------------

- (30) 5-20R outlets
- (2) 20 A circuit breakers
- Surge suppressor
- Digital display

## MPD 329004-000

<b>Voltage</b>  100-240 Vac	<b>Current</b>  24/30 Amps	<b>Inlet</b>  L6-30P/9ft	<b>Outlets</b>  C13 / C19	<b>Enclosure</b>  Full Rack
-----------------------------------	----------------------------------	--------------------------------	---------------------------------	-----------------------------------

- (24) C13 outlets
- (6) C19 outlets
- (2) 20 A circuit breakers
- Surge suppressor
- Digital display

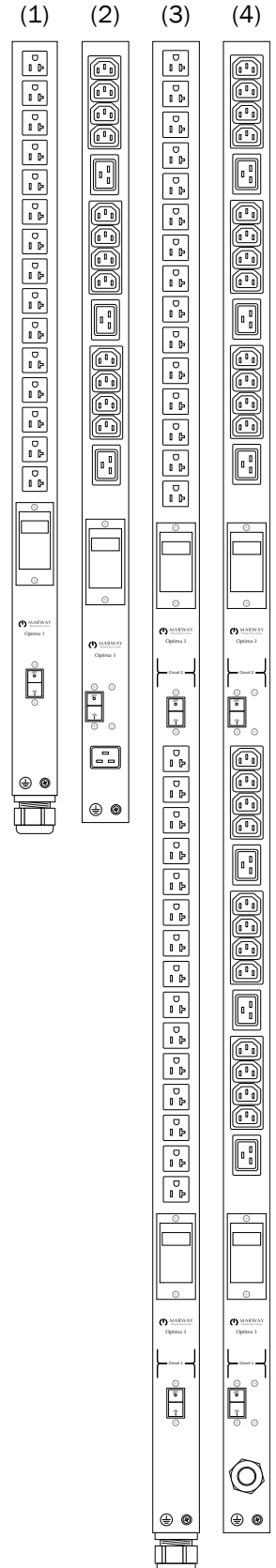

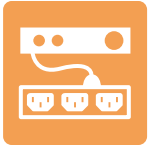

# Commander™ UCP 5000 and 5100

Universal Control Panel for On/Off/EPO

## Consolidated Control

Marway's UCP 5000 / 5100 consolidates into a single control panel the on, off, and EPO control features to remotely manage one or more power distribution units. Marway PDUs with a remote EPO controller can then provide power on/off of downstream equipment switched in unison.

### Feature Highlights

- Connects to one or multiple PDUs.
- On, Off, EPO control to all connected PDUs.
- EPO reset button.
- EPO audio alarm with on/off switch.
- “Control Power” lamp indicates UCP has power
- Local circuit breaker protects UCP circuitry.
- Built-in lamp test button.
- Timer accumulates UCP On time.
- Two control outputs for Marway PDUs (J1, J2)
- Two auxiliary isolated control outputs (J4, J5)
- One input for additional external EPO buttons (J3).
- Front and back panel convenience outlets. UCP 5000 has 5-15, UCP 5100 has C13.
- UL and CE certified.

## On/Off Circuit

The power on/off circuit is the primary feature of the Commander panels. Lighted on/off switches provide easily recognized status on the UCP, and connections on the back of the chassis allow for remote indication as well. Dry contacts, connected at the back panel, provide two isolated channels of on/off control (each can be of a unique power spec), which can be externally branched, to provide a power-on signal to as much equipment as needed.

## EPO Circuit

In some applications, particularly those with machinery connected to a PDU, an Emergency Power Off (EPO) may be required. An EPO is a large, prominently placed push button used to disconnect power to all devices connected to the PDU. These buttons are intended to be easy to find and press in an emergency scenario, such as when a person identifies a hazardous condition not handled by the end-point equipment itself. The UCP 5000 and 5100 models provide this EPO circuit including capabilities to integrate additional remotely located EPO buttons.



Universal control panels (UCPs) provide on, off, and EPO control for one or more PDUs to consolidate control of equipment in one rack or even multiple racks. Model 5000 units have NEMA 5-15 inlet and outlets. Model 5100 has a C14 inlet and C13 outlets. Both models are available with either normally-open (N.O.) or normally-closed (N.C.) EPO contacts.

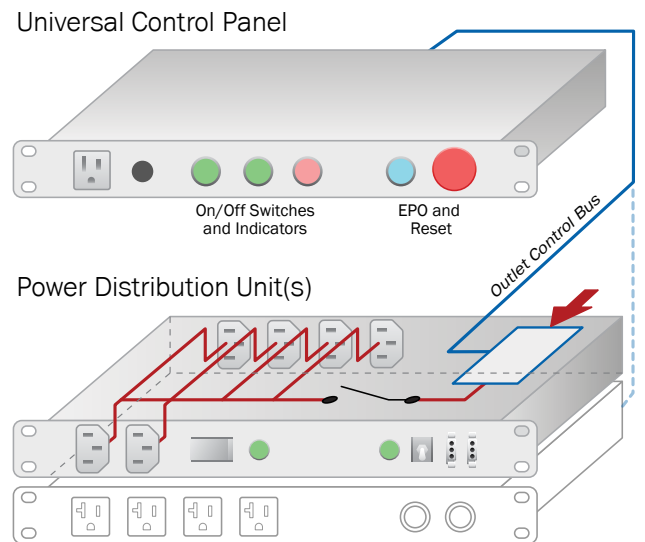

### Relevant Links

- [Commander web page](#)
- [Commander Operating Guide](#)

# Commander UCP 5000/5100 Universal Control Panels

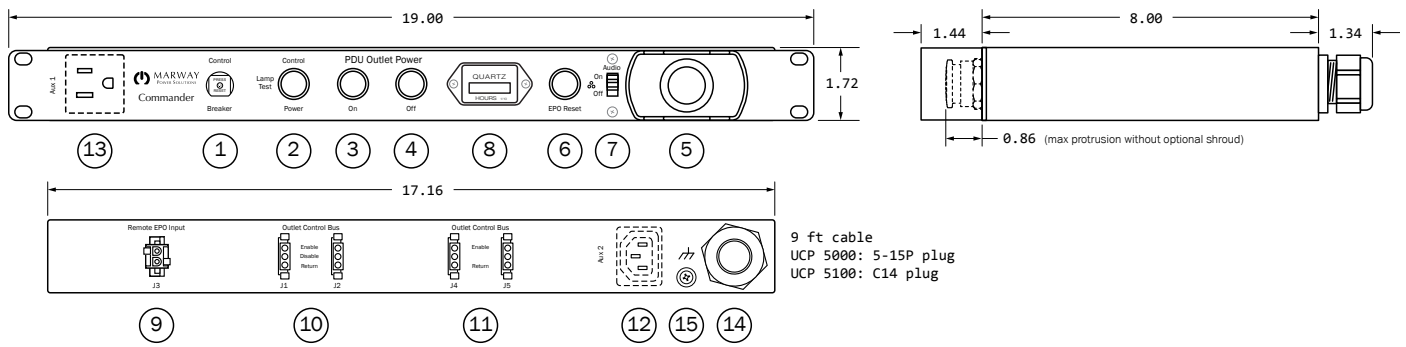

## 5000/5100 Map of Features

- (1) 1 amp breaker, protecting built-in controls.
- (2) Control Power lamp / Lamp Test pushbutton. Functions as a lamp, and as a pushbutton. The lamp indicates that power is available to the UCP controls. The momentary pushbutton is used to temporarily illuminate all indicators as confirmation that they are still operable.
- (3) PDU Power On lamp/button. The lamp indicates that the outlet control bus is enabled (rear connectors J1, J2, J4, J5). The momentary pushbutton is used to set the outlet control bus to the enabled state. This is typically used to allow PDU outlets to be powered. However, on some PDU models, local controls may still override this signal, and keep outlets off.
- (4) PDU Power Off lamp/button. The lamp indicates that the outlet control bus is disabled. The momentary pushbutton is used to set the outlet control bus to the disabled state. This is typically used to prevent PDU outlets from being powered. However, on some PDU models, local controls may still override this signal, to force outlets on.
- (5) EPO push button. When pressed, the outlet control bus is disabled, and the UCP is put into an EPO state. All remote-EPO-controlled outlets in PDUs connected to the UCP should be disabled (unless local PDU overrides have them forced on). The EPO Reset lamp will be illuminated, and the audible alarm will be activated (if switch (7) is on).
- (6) EPO status lamp / EPO Reset button. The lamp will be illuminated whenever the UCP is in an EPO state. Pressing the button will turn off the EPO state, and put the PDU into a disabled state (EPO lamp will not be lit, and the audible alarm will be silenced). The PDU Power Off lamp will be lit. EPO-controlled outlets will remain off.
- (7) Audible Alarm on/off switch. When on, a speaker is activated when the UCP is in an EPO state. The switch is intended to be used to configure the UCP to have the audible alert enabled or disabled as an element of the EPO state.
- (8) Time accumulation meter. Displays the accumulated time in which the PDU Power On has been active (the UCP's enabled state).
- (9) J3 Remote EPO Input. Allows additional EPO buttons to be connected to the UCP—all of which will operate exactly as the built-in button (5). Remote EPO buttons cannot be accompanied by EPO Reset buttons. Only one reset button (6) for the system is available.
- (10) J1 and J2 Outlet Control Bus connectors. Intended for interfacing with Marway PDUs with remote EPO control to provide the enabled and disabled signals. These connectors are wired in parallel.
- (11) J4 and J5 Outlet Control Bus isolated auxiliary connectors. Provides dry contacts which signal the outlet power enabled state of the UCP (when (4) has been pressed, and is illuminated). These connectors function in parallel, but each is a separate dry contact.
- (12) Auxiliary convenience outlet. This outlet is always powered. It is a NEMA 5-15 on 5000 models, and C13 on 5100 models.
- (13) Auxiliary convenience outlet. This outlet is always powered. It is a NEMA 5-15 on 5000 models, and C13 on 5100 models.
- (14) Power inlet. The plug will be a 5-15P on 5000 models, and a C14 on 5100 models.
- (15) Chassis ground connection.

## Using J1 / J2 for Remote On/Off/EPO Control

Connectors J1 and J2 are wired in parallel. Pin 1 becomes activated when the UCP Control Power On is pressed, and Pin 2 becomes activated when the EPO button is pressed. Pin 3 is the remote signal return. Use these connectors to drive Marway PDU's with the remote EPO feature.

- Connector: AMP #1-480304-0, mating #1-480305-0
- Voltage 250 Vac maximum
- Current 4.0 amps maximum

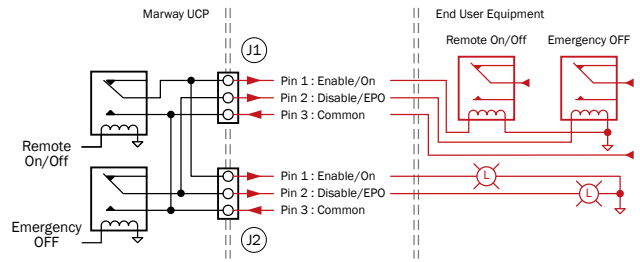

This diagram shows conceptually what's inside the UCP, and how to use the J1 and J2 signals for remote control of Marway PDU's, other equipment, or indicators.

## Using J4 / J5 for Auxiliary Power On

Connectors J4 and J5 are independent (not wired in parallel), but operate in exactly the same way in unison. Pin 1 on each connector becomes active when the UCP Control Power is on. Pin 2 is unused. Pin 3 is the remote return. Use these connectors to generate remote power on signals on Marway and non-Marway PDU's, or other downstream equipment.

- Connector: AMP #1-480304-0, mating #1-480305-0
- Voltage 250 Vac maximum
- Current 4.0 amps maximum

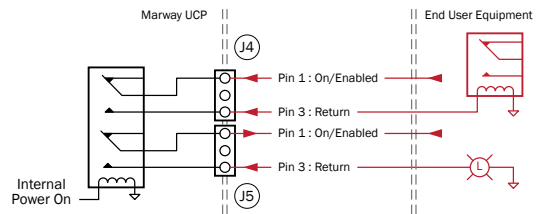

This diagram shows conceptually what's inside the UCP, and a simplified example of how to use the J4 and J5 connectors for auxiliary power on signals.

## Using J3 for Remote EPO

Connector J3 is used to allow one or more remote EPO switches. Each switch, if there is more than one, would be wired in series or parallel as indicated in the diagram to the right. There is no remote reset. For safety, there is only the one reset at the UCP.

N.O. Models — Shorting J3 pin 1 to pin 2 returns the 24 Vdc signal, and creates an EPO Activated state.

N.C. Models — J3 requires a shorting jumper when no external switches are used. Adding switches in series to break Pin1 from Pin 2 creates an EPO Activated state.

- Connector: AMP #1-480699-0, mating #1-480698-0

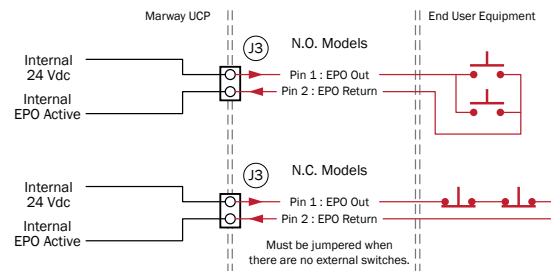

This diagram shows conceptually what's inside the UCP, and how to use the J3 connector to attach one or more external EPO buttons.

## Using Aux1 / Aux2 Outlets

These two outlets are wired directly to the input power, and are always powered. They are not subject to the On/Off/EPO controls of the UCP, nor are they subject to the front panel circuit breaker. The combined load of both outlets is subject to the input power rating of the unit.

NOTE: The voltage rating of connector J3 is a significant change from the UCP 3500. The UCP 5000/5100 models use 24 Vdc, whereas the UCP 3500 uses 20 Vac.



# Commander UCP 5000/5100 Universal Control Panels

5000 Dimensions	5000 Electrical	5000 Environment
1U Rack-mount chassis Weight: approx. 9 lbs Front Width: 19.00" Chassis Width: 17.16" Chassis Height: 1.72" Chassis Depth 8.00"	Input power rating: 120 Vac, 50/60 Hz Current Load: 12 A continuous / 15 A maximum Power consumption without Aux 1, 2: < 1 amp J1: AMP #1-480304-0, 250 Vac, 4 A max. J2: AMP #1-480304-0, 250 Vac, 4 A max. J3: AMP #1-480699-0, 24 Vdc, no load J4: AMP #1-480304-0, 250 Vac, 4 A max. J5: AMP #1-480304-0, 250 Vac, 4 A max. Aux 1: NEMA 5-15R, 120 Vac ** Aux 2: NEMA 5-15R, 120 Vac ** ** combined load of Aux1 and Aux2 is subject to the 12 A rating	Operating Temperature: 32 °F to 122 °F Maximum Altitude: 6,562 feet Relative Humidity: 5% to 85% non-condensing

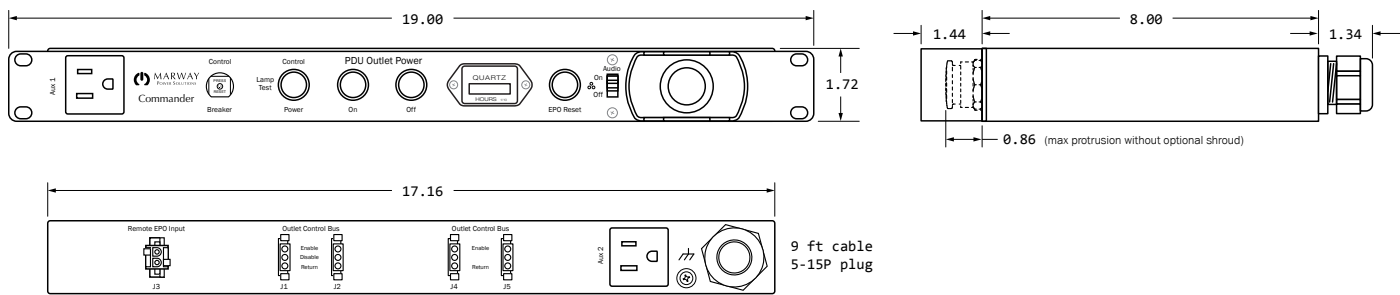

5100 Dimensions	5100 Electrical	5100 Environment
1U Rack-mount chassis Weight: approx. 9 lbs Front Width: 19.00" Chassis Width: 17.16" Chassis Height: 1.72" Chassis Depth 8.00"	Input power rating: 100-240 Vac, 50/60 Hz Current Load: 10 A Power consumption without Aux 1, 2: < 1 amp J1: AMP #1-480304-0, 250 Vac, 4 A max. J2: AMP #1-480304-0, 250 Vac, 4 A max. J3: AMP #1-480699-0, 20 Vac, no load J4: AMP #1-480304-0, 250 Vac, 4 A max. J5: AMP #1-480304-0, 250 Vac, 4 A max. Aux 1: IEC C13, 100-240 Vac ** Aux 2: IEC C13, 100-240 Vac ** ** combined load of Aux1 and Aux2 is subject to the 10A rating	Operating Temperature: 32 °F to 122 °F Maximum Altitude: 6,562 feet Relative Humidity: 5% to 85% non-condensing

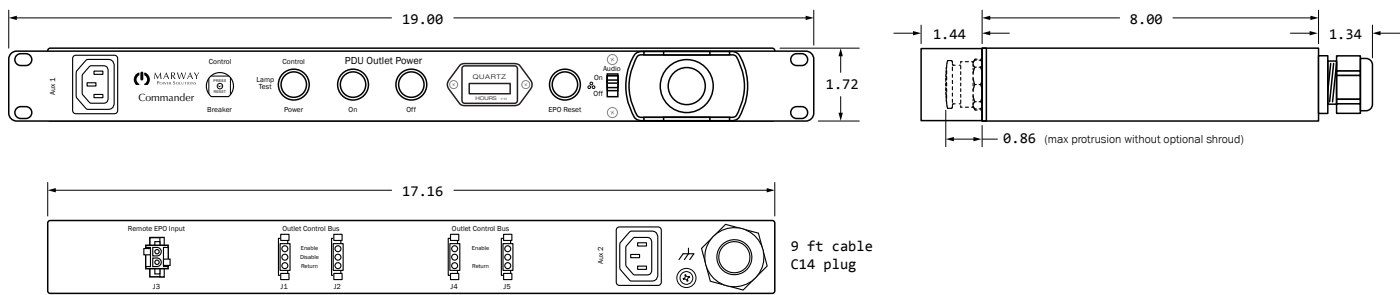

[1] Continuous load duty rating is 80% of Amps Max.

All Models – General chassis style shown. Details may vary. Specifications and availability subject to change without notice.

# Commander UCP 5000/5100 Universal Control Panels

## UCP 5000-000G (N.O) / -001G (N.C.)

Amps Max<sup>1</sup>  
**15**

NEMA Outlets  
**5-15**

1ph Vac  
**120**

Cable Inlet 9 ft  
**5-15P**

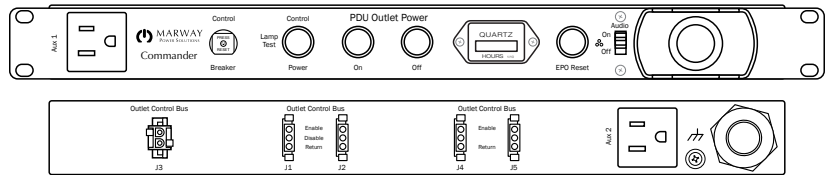

The -000 UCP models are compatible with “normally-open EPO” Marway PDUs. The -001 UCP models require that the PDU also be compatible with “normally-closed EPO” circuits. All Optima 5 and 8 series standard PDUs are N.O. by default (the -000 version of the models). Order the -001 version of the Optima 5 or 8 series PDUs to get N.C. EPO functionality.

## UCP 5100-000G (N.O) / -001G (N.C.)

Amps Max<sup>1</sup>  
**10**

NEMA Outlets  
**C13**

1ph Vac  
**100-240**

Recessed Male Inlet  
**C14**

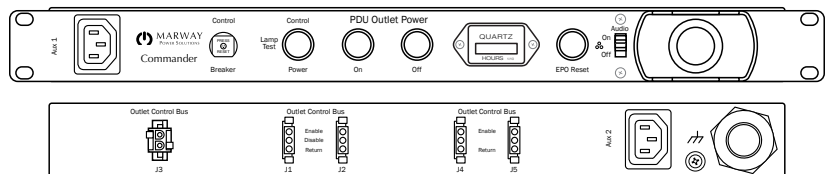

The -000 UCP models are compatible with “normally-open EPO” Marway PDUs. The -001 UCP models require that the PDU also be compatible with “normally-closed EPO” circuits. All Optima 5 and 8 series standard PDUs are N.O. by default (the -000 version of the models). Order the -001 version of the Optima 5 or 8 series PDUs to get N.C. EPO functionality.

[1] Continuous load duty rating is 80% of Amps Max.

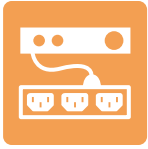

# Commander™ UCP 4900

Universal Control Panel for On/Off/EPO

## Consolidated Control

Marway's UCP 4900 consolidates into a single control panel the on, off, and EPO controls to manage one or more power distribution units. PDUs with remotely switchable outlets can therefore provide power on/off of downstream equipment switched in unison. Additionally, the EPO circuit improves safety of the combined power system.

### Feature Highlights

- Simple, dry-contact operation for compatibility with Marway PDUs.
- Connects to one or multiple PDUs.
- On/Off power control to connected PDUs.
- EPO for all connected PDUs.

## On/Off Circuit

The power on/off circuit is the primary feature of the UCP 4900. A self-indicating on/off switch provides easily recognized status on the UCP. A 15-foot cable terminating in an AMP/TE connector can be used to connect to a single PDU. Multiple PDUs can be controlled if the PDU provides daisy chained connectors, or if the UCP connector is first connected to a junction providing multiple parallel outputs. Dry contacts provide compatibility with both ac and dc voltage.

## EPO Circuit

In some applications, particularly those with machinery connected to a PDU, an Emergency Power Off (EPO) may be required. An EPO is a large, prominently placed push button used to disconnect power to all devices connected to the PDU. These buttons are intended to be easy to find and press in an emergency scenario, such as when a person identifies a hazardous condition not handled by the end-point equipment itself. The UCP 4900 provides this EPO button to trigger a shutdown of the PDU(s).

There are two options for the EPO button: a normally-open type, and a normally-closed type. The normally-open type is compatible with the majority of Marway's legacy PDUs. The normally-closed type can be opted for with newer PDUs which have also been configured for normally closed operation.



The 4900 series of Universal control panels (UCPs) provide basic on, off, and EPO control for one or more PDUs which can consolidate control of equipment in one rack or multiple racks.

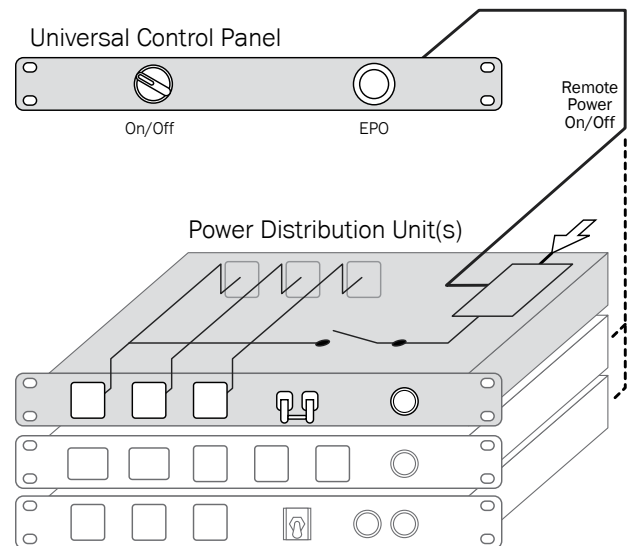

### Relevant Links

- [Commander web page](#)
- [Commander Operating Guide](#)

# Commander UCP 4900 Universal Control Panel

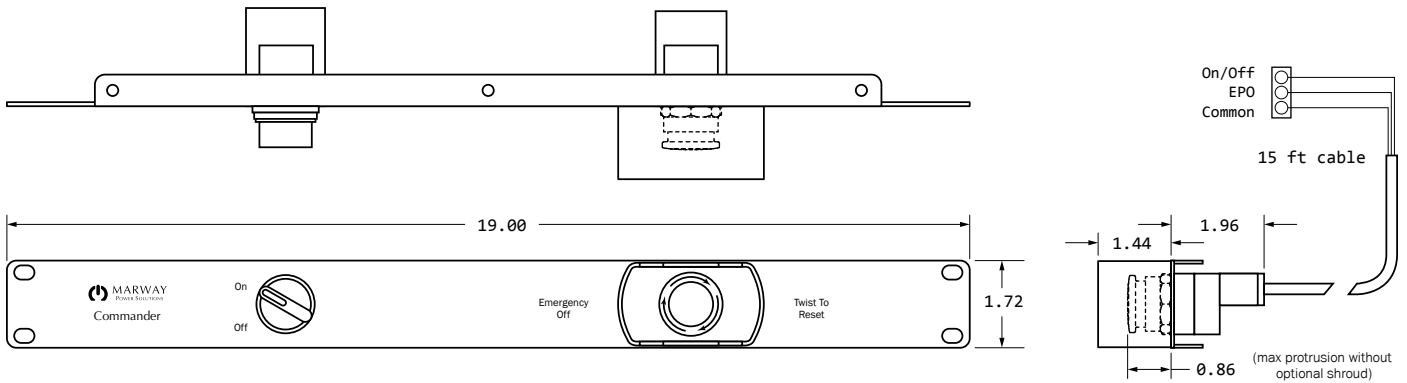

## Dimensions

1U Rack-mount chassis

Front Width: 19.00"

Chassis Height: 1.74"

Chassis Depth 1.96"

Chassis is "open frame" and provides top and bottom flanges for rigidity. #6-32 screw holes allow for attaching wire clamps.

## Electrical

Interface: two dry-contact signals

Connector: AMP #1-480305-0, 250 Vac, 3 A max.

Remote cable: 15 feet, 3 A max.

## Environment

Operating Temperature: 32°F to 122°F

Maximum Altitude: 6,500 feet

Relative Humidity: 5% to 85% non-condensing

When mated to a Marway PDU remote connector, no further work is needed. These diagrams show conceptually what's inside the UCP, and a simplified example of how to use the available connections for remote control of non-Marway PDUs or other equipment.

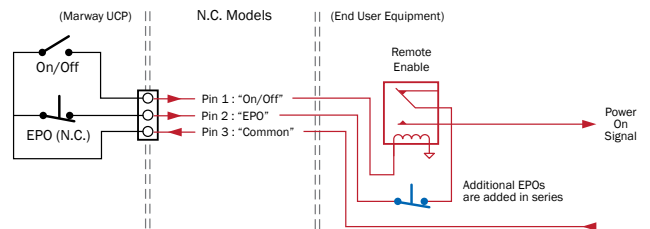
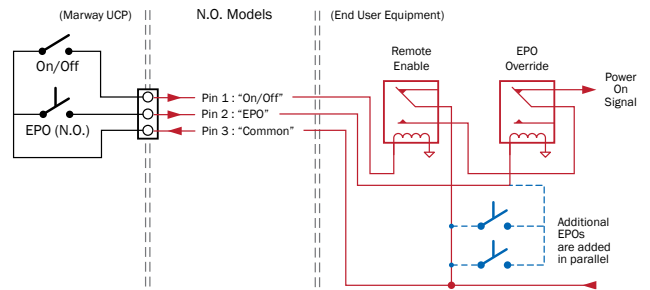

## Model Numbers

Model Number	EPO Action <sup>1</sup>	Guard
UCP 4900-000G	N.O.	YES
UCP 4900-001G	N.C.	YES

1: The -000 UCP models are compatible with "normally-open EPO" Marway PDUs. The -001 UCP models require that the PDU also be compatible with "normally-closed EPO" circuits. All Optima 5 and 8 series standard PDUs are N.O. by default (the -000 version of the models). Order the -001 version of the Optima 5 or 8 series PDUs to get N.C. EPO functionality.



**Optima™ PDUs**  
Custom and Standard  
for Ac, Dc, 400Hz

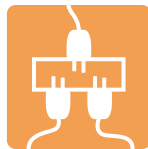

**TwinPower™ ATs**  
Auto Transfer Switches  
for power redundancy



**Commander™ UCPs**  
Remote and EPO  
control panels



**PowerPlus™**  
Turn-key rack  
power integration

Contact Our Power Specialists  
[info@marway.com](mailto:info@marway.com) • 800-462-7929

Marway is a HEICO Electronic Technologies company.